

4320015

Model 432

Shopper

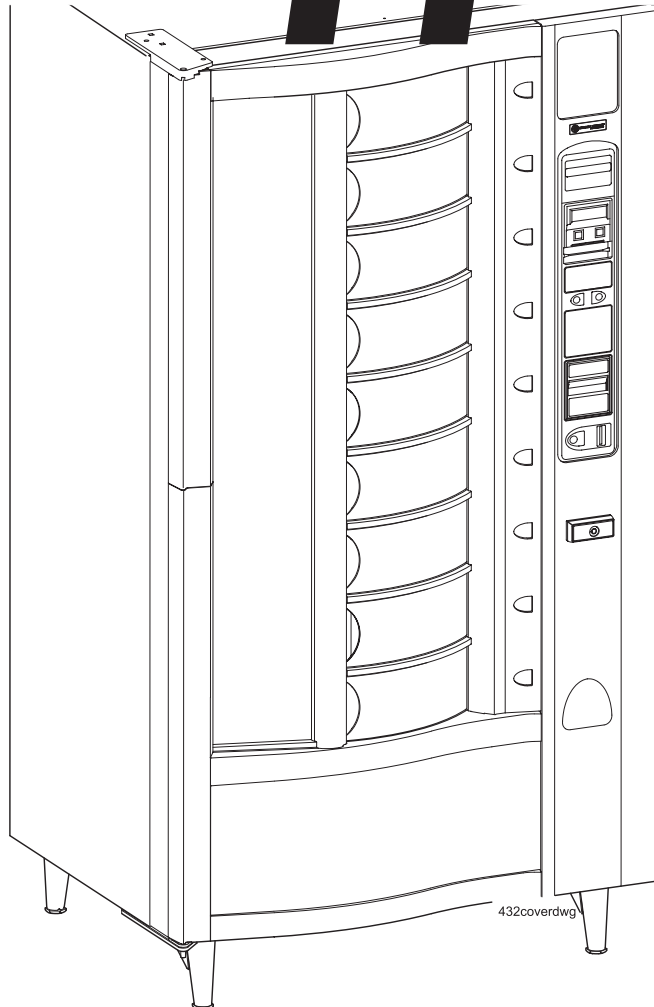

Operators' Guide

CRANE[®]

MERCHANDISING SYSTEMS™ A Crane Co. Company
NATIONAL VENDORS[®]

12955 Enterprise Way
Bridgeton, Missouri 63044-1200
(314) 298-3500
www.CraneMS.com

Copyright© 10-04



4320015

Congratulations on your choice of a National Vendors Model 432 Shopper.

Your Shopper embodies the performance and dependability you've come to expect in a National Vendors merchandiser. This product will provide years of dependable, quality service.

This machine has been engineered to our own rigid safety and performance requirements and manufactured in accordance with the safety standards of Underwriters Laboratories (UL) and the Canadian Standards Association (CSA). It has been designed to comply with the National Automatic Merchandising Association (NAMA) "Standard for the Sanitary Design and Construction of Food and Beverage Vending Machines" ..



To maintain this degree of safety and to continue to achieve the level of performance built into this machine, it is important that installation and maintenance be performed so as to not alter the original construction or wiring and that replacement parts are as specified in the Parts Manual. Your investment in this equipment will be protected by using this Operators' Guide and the Parts Manual in your operation, service and maintenance work. By following prescribed procedures, machine performance and safety will be preserved.



CRANE MERCHANDISING SYSTEMS PARTS & SUPPORT:
PARTS: 1-800-621-7278 SERVICE: 1-800-628-8363
www.CraneMS.com

For faster service, please have your account number ready before calling.

Table of Contents

Initial Set-Up	1
Preparing the Merchandiser	1
Health Shutoff Control	2
Test the Health Control	3
Unpack And Inspect	4
Utility Requirements	4
Installation	5
Install the Coin Mechanism	6
Install the Door Lock	8
Install the Money Box Lock	8
Drum and Tray Setup	9
Adjust the Product Dividers	9
Adjust the dividers	11
Adjust the Delivery Door Stops	12
Shelf Assembly Removal and Replacement	13
Vend Door Removal and Replacement	13
Installing Automatic Vend Doors	14
Operating Automatic Vend Doors	15
Adjust the Stop Pin	17
Drum Assembly Removal and Replacement	18
Load the Merchandiser	21
Programming Introduction	22
The Displays	22
The Function Keys	23
Other Keys	23
Control Panel Buttons Explained	24
Programming Flow Charts	25
Programming Procedures	27
Gain Access to the Supervisor Mode	27
Enter a New Supervisor Code	27
Enter a New Data Recall Code	28
Lock or Unlock Mode or Payout Keys	29
Turn Talker Mode On or OFF	29
Set Printer or DEX Options	29
Select Printer Baud Rate (Printer Mode Only)	30
Lock or Unlock Data Clearing Access	31
Select Display Language	31
Select Coin Mechanism and Options	31
Select Bill Validator and Options	32
Initial Setup of a Non-Standard Bill Validator	33
Select Card Reader and Options	33
Select Monetary Options	34

Set Up Vend Fail Credit Option	35
Set Up Winner Mode	36
Set Shop Zones	37
Set Number of Compartments	37
Set Zone Preference	39
Set View Delay Time	39
Set Door Delay Time	39
Set Automatic Door Delay Time	39
Set Align/No Align Options	40
Turn Tamper Check On or Off	41
Check for Tampering	41
Turn PowerSave On or Off	42
Turn Glass Heaters On or Off	42
Display Prices	43
Change Temperature	43
Show the Temperature in Standby Mode	43
Set Defrost Options	44
View Software Version	45
Set the Time	45
Set Day of the Week, Month, Date, and Year	45
Set Daylight Saving Time Option	45
Set Time-Of-Day Inhibited Vending	46
Set Time-Of-Day Free Vending	46
Set Time-Of-Day Discount Vending	46
Time Interval Editing	47
Edit Custom Messages	50
Select a Standby Message	52
Select an Out-Of-Service Message	52
Select a Freevend Message	52
View Machine Temperature	53
Payout Coins	53
Set Prices	54
View Nonresettable Sales and Vend Data	55
View Total Paid Sales	56
View Discount Sales by Time Interval	57
View Total Paid Vends	57
View Card Reader Paid Sales	57
View Total Unpaid Sales	58
View Total Unpaid Vends	58
View Free Vends	59
View Winners	59
View Freevend Sales by Time Interval	59
View Total in the Bill Validator	59
View Time Data	60
View Machine ID Number	61
Clear All Resettable Data	61

Clear Paid Sales Data Only 62

Test Vend Selections and Verify Credit Added 62

Door Solenoid Test 62

Test Door Motor 62

Test Door Heaters 63

Test lamps 63

Test the Display 63

Download Data To a PDCD 64

View Diagnostic Messages 65

Set Freevend Options 68

Service and Sanitation 69

General 70

Daily Service 70

Section 1: Initial Set-Up

PREPARING THE MERCHANDISER

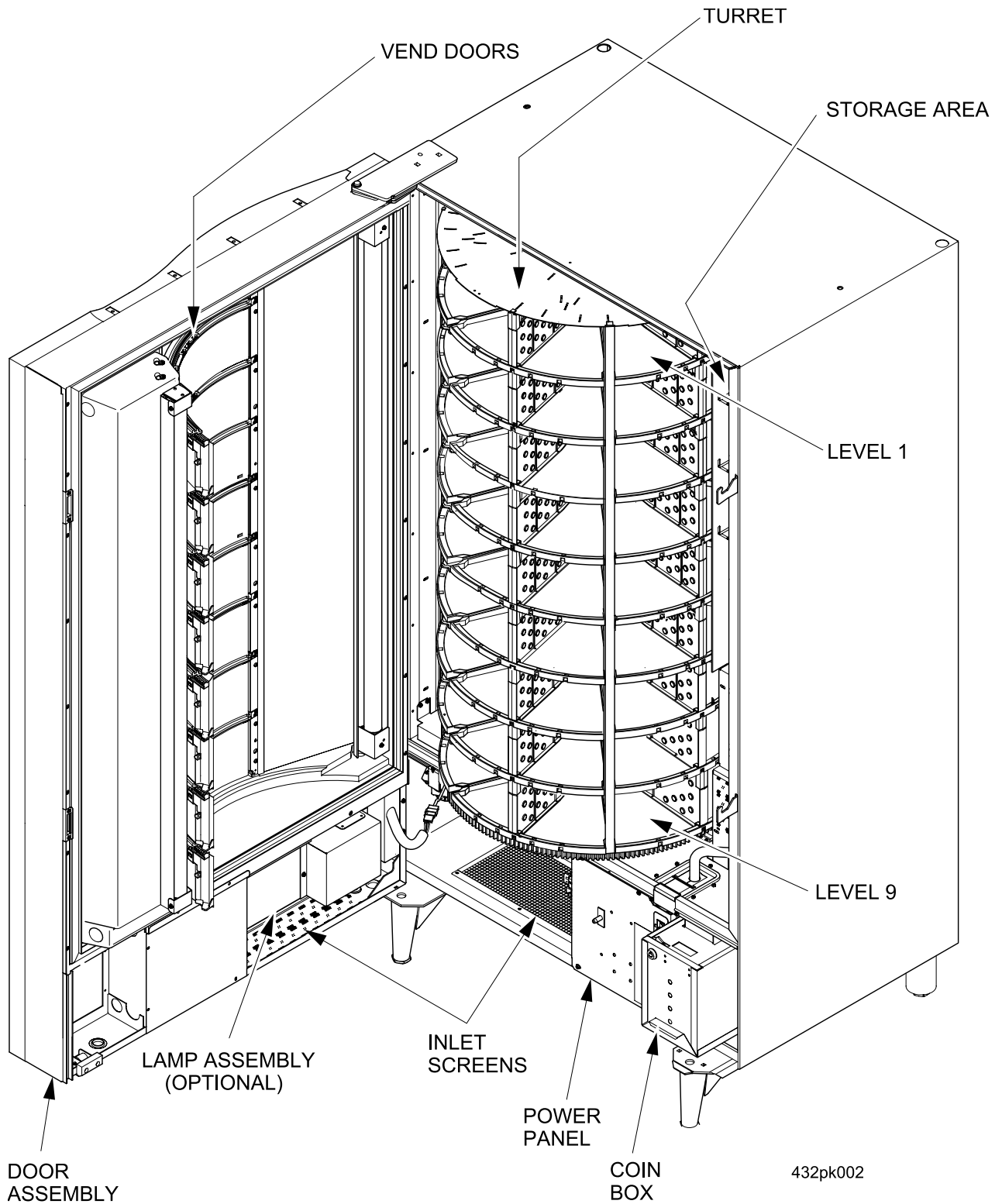

FIGURE 1: 432 MERCHANDISER

HEALTH SHUTOFF CONTROL

Your Shopper merchandiser is equipped with electronic health shutoff control software. Health Shutoff Control is required by state and local health authorities and is a requisite for NAMA approval for perishable food vending.

The health shutoff control prevents the merchandiser from vending product that could be spoiled. It monitors the temperature within the cabinet and will automatically go into an out-of-service mode should any of the following conditions occur:

- The temperature of the refrigerated cabinet does not fall to 41° F (5° C) within 30 minutes after the door of the refrigerated cabinet is closed.
- The temperature of the refrigerated cabinet does not fall to 41° F (5° C) within 30 minutes after a defrost.
- The temperature of the cabinet rises above 41° F (5° C) for more than 15 minutes without the door of the refrigerated cabinet having been opened, except within 30 minutes of a defrost.
- For testing purposes, the temperature of the cabinet rises above 41° F (5° C) for at least one second with the refrigerated door open.

When health shutoff control is triggered, the display will read *TEMPORARY OUT OF SERVICE*. When the monetary door is opened, the message changes to *HC.ER*, and the date, time, and maximum cabinet temperature reached are displayed. When the refrigerated cabinet door is closed, the health shutoff control timer will reset and the compressor will have another 30 minutes to cool the cabinet below 41° F (5° C).

The Health Shutoff Control may trigger during initial setup, as it will take time for the compressor to cool the cabinet the first time. Therefore, National Vendors recommends leaving the refrigerated compartment empty until the cabinet temperature is low enough to satisfy the health control.

TEST THE HEALTH CONTROL

The purpose of the Health Control Automatic Shutoff is to disable the vending mechanism whenever the machine does not maintain the air temperature in the food storage compartment at or below 41°F (5°C). The temperature shutoff requirement does not apply for 30 minutes after filling, servicing or a defrost cycle.

NOTES:

- a. The Automatic Health Shutoff Control timer resets every time the Refrigerated Cabinet Door is closed.
 - b. The internal cabinet temperature can be viewed on the credit display by simultaneously pressing both turret rotation buttons located on the front of the monetary compartment.
1. Check the temperature of the food compartment by depressing both turret direction buttons simultaneously to ensure that the machine is not in the 30-minute recovery period that occurs after the main door is closed following filling, servicing or after a defrost cycle. If the machine is in the 30-minute recovery period, the time remaining will display. Before proceeding, wait until the recovery period ends.
 2. Open the monetary door and then the main door a minimum of 45 degrees to allow the food compartment temperature sensor to warm. Observe the cabinet temperature on the credit display by depressing both turret direction buttons. When the temperature on the display reaches 42° F (5.5°C) the message "Temporary Out of Service" will display. This verifies that the vending mechanism of the machine has been disabled as required. With the door open, the sensor temperature will typically reach 42° F (5.5°C) in less than 5 minutes.
 3. Press the turret direction buttons and the message "HCER" (Health Control Error) will appear. This is the message a service person would observe after opening the monetary door.
 4. Close the main and monetary doors. You may observe the recovery time and temperature by again depressing the turret direction keys.

UNPACK AND INSPECT

1. Carefully remove the merchandiser from its shipping carton and place it on a level surface.
2. Inspect the outside of the merchandiser for dents, scratches, or any damage resulting from improper handling.
3. Open the monetary access panel with the main key. Unlatch or unlock the monetary door. If the merchandiser has the optional monetary lock, this key will be in the coin return receptacle.
4. Unlock the main door latches. Open the main door.
5. Inspect the inside of the cabinet. Observe the location and position of the packing material should you need to reuse it. Carefully remove all packing material.
6. If you saw any damage when you unpacked the merchandiser, file a claim immediately with the carrier.
7. Instructions for installing the optional Base Plate are included with the Base Plate Assembly when shipped.
8. Inspect the merchandiser's electrical connectors and components.

UTILITY REQUIREMENTS

This merchandiser is supplied with a service cord for the country of use and is terminated in a grounding type plug. The wall receptacle used for this merchandiser must be properly polarized, grounded, and of the correct voltage. Operating the merchandiser from a source of low voltage will **VOID YOUR WARRANTY**. Each merchandiser should have its own electrical circuit and that circuit should be protected with a circuit breaker or fuse conforming to local regulations.

Voltage Check - Place the leads of a voltmeter across the LINE (LIVE) and NEUTRAL terminals of the wall receptacle. The voltmeter should indicate 110-130 volts ac for 120 volt, 60 Hz locations, or 220-240 volts ac for 230 volt, 50 Hz locations.

Polarity Check - Place the leads of a voltmeter across the LINE (LIVE) and GROUND terminals of the wall receptacle. The voltmeter should indicate 110-130 volts ac for 120 volt, 60 Hz locations, or 220-240 volts ac for 230 volt, 50 Hz locations.

Noise Potential Check - Place the leads of a voltmeter across the NEUTRAL and GROUND terminals of the wall receptacle. The voltmeter should indicate 0 volts ac. A measurement greater than 1.5-2.0 volts ac could result in problems for the merchandiser's electronic circuitry caused by electrical noise.

Any deviation from these requirements may result in unreliable performance of the merchandiser.

Section 2: Installation

NOTICE

This merchandiser is intended for INDOOR use only.

CAUTION

Level the merchandiser on a flat, solid, stable floor or base foundation. **IF THIS IS NOT DONE, PERSONAL INJURY AND/OR DAMAGE TO EQUIPMENT MAY RESULT!**

1. Move the merchandiser to the desired location. The merchandiser fits through a 32" door, but it may be necessary to remove the door and drum in order to move the merchandiser through a narrower doorway. Be careful when disconnecting the wiring harness. To reconnect wiring, refer to the figure below.

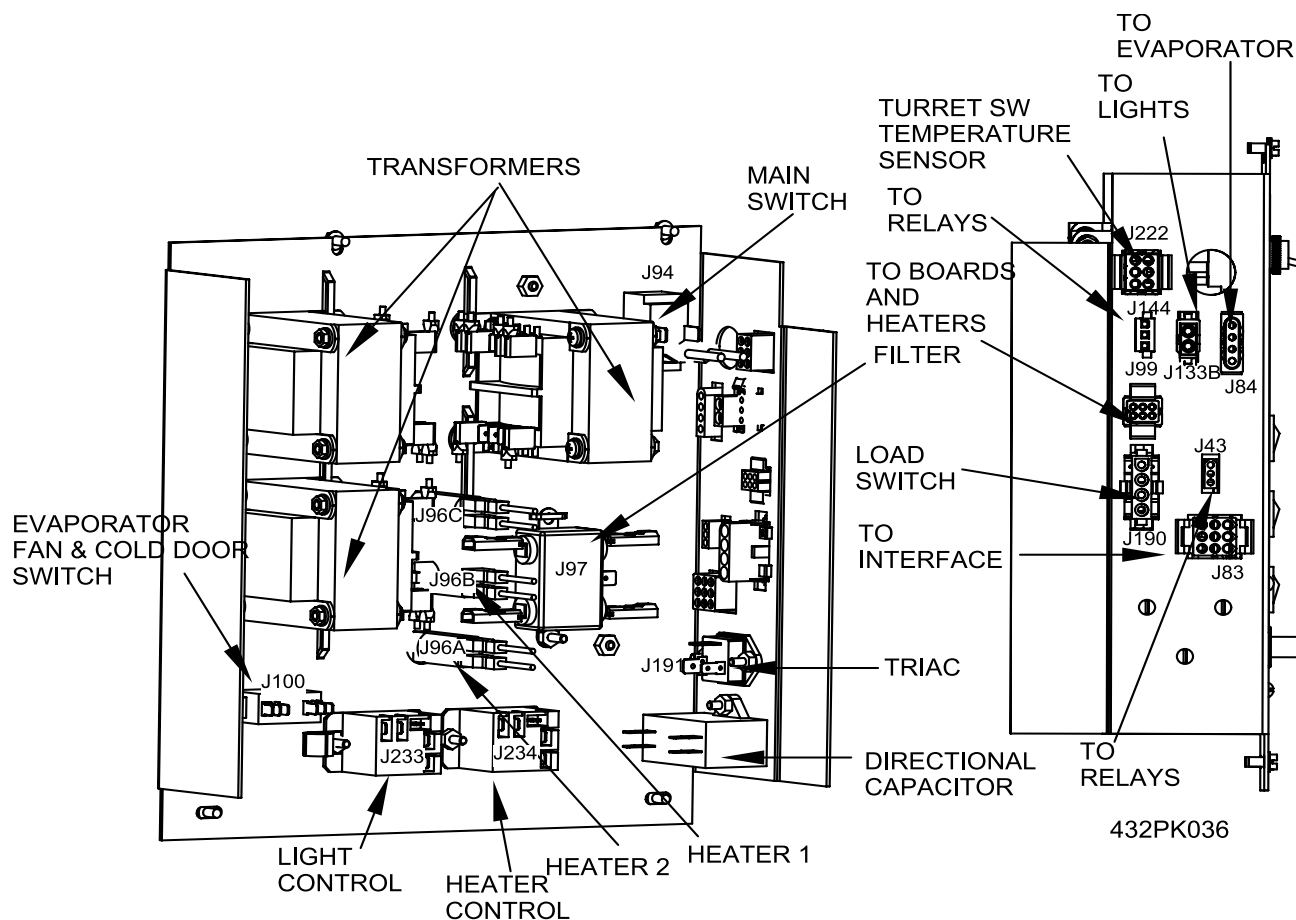

FIGURE 2: 432 HARNESS WIRING

2. Position the rear of the merchandiser at least 6 inches (15 cm) from any wall.
3. Using a spirit level, adjust the legs with an open end or adjustable wrench until the merchandiser is level front to back and side to side.

4. For "bank style" installations of multiple merchandisers:
 - a. Position the first machine at the center of the location, level it, and then work towards the end of each bank. Extend the leg levelers only as required to level the machine.
 - b. Position and level the remaining machines.
5. Make sure the main power switch is set to OFF.

IMPORTANT

Do not apply power to the merchandiser until you have done the power source checks outlined above. Equipment damage could result from improper supply voltage.

6. Plug in the merchandiser.
7. Turn the main power switch ON and close the cabinet door. The display lamp will light, and the evaporator fan will run. The compressor will start within 1 minute.

INSTALL THE COIN MECHANISM

WARNING

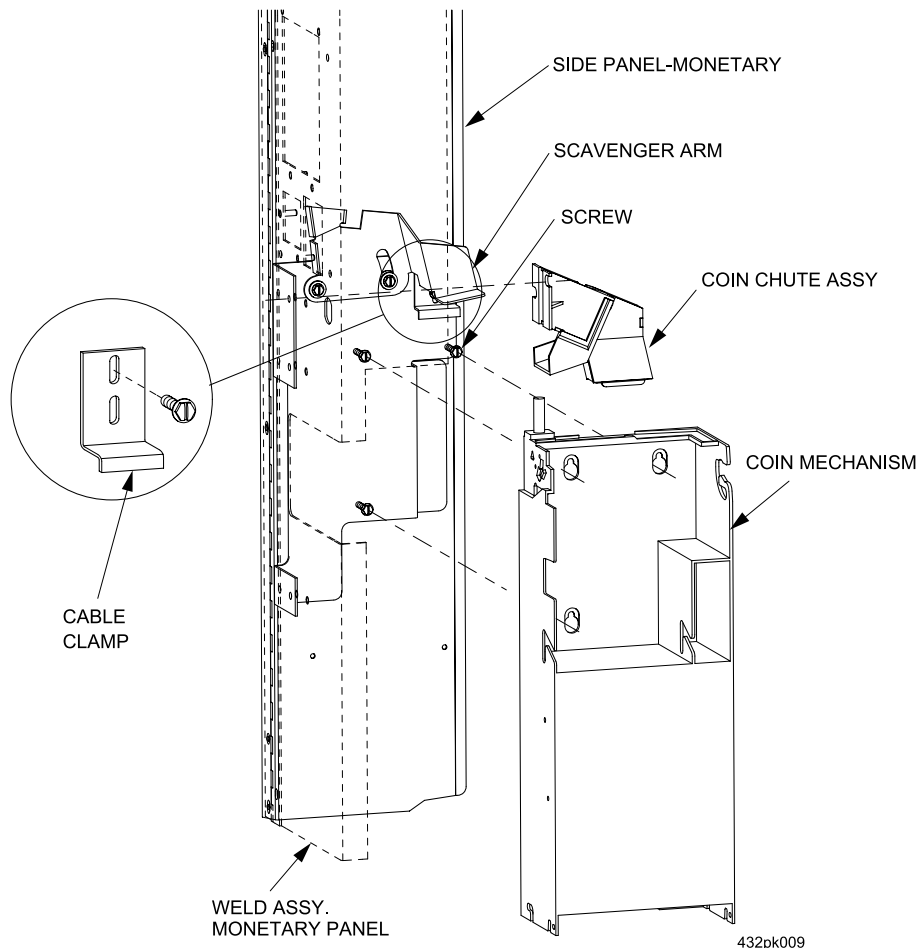

Make sure the main power switch is turned OFF before you work on the merchandiser. Failure to do so could result in serious injury or death.

1. Turn OFF the main power switch. Refer to the instructions provided with the coin mechanism and remove the coin validator assembly.
2. Set any option switches as desired.
3. Loosen the coin mechanism mounting screws (p/n 9900106) on the merchandiser so they stand off about 1/8" (0.3 cm).
4. Position the coin mechanism so the three keyed holes fit over the mounting screws. Pull down on the coin mechanism to seat the screws in the keyways.
5. Tighten the mounting screws and reinstall the coin validator assembly.
6. Tighten the cable clamp down onto the validator wiring.

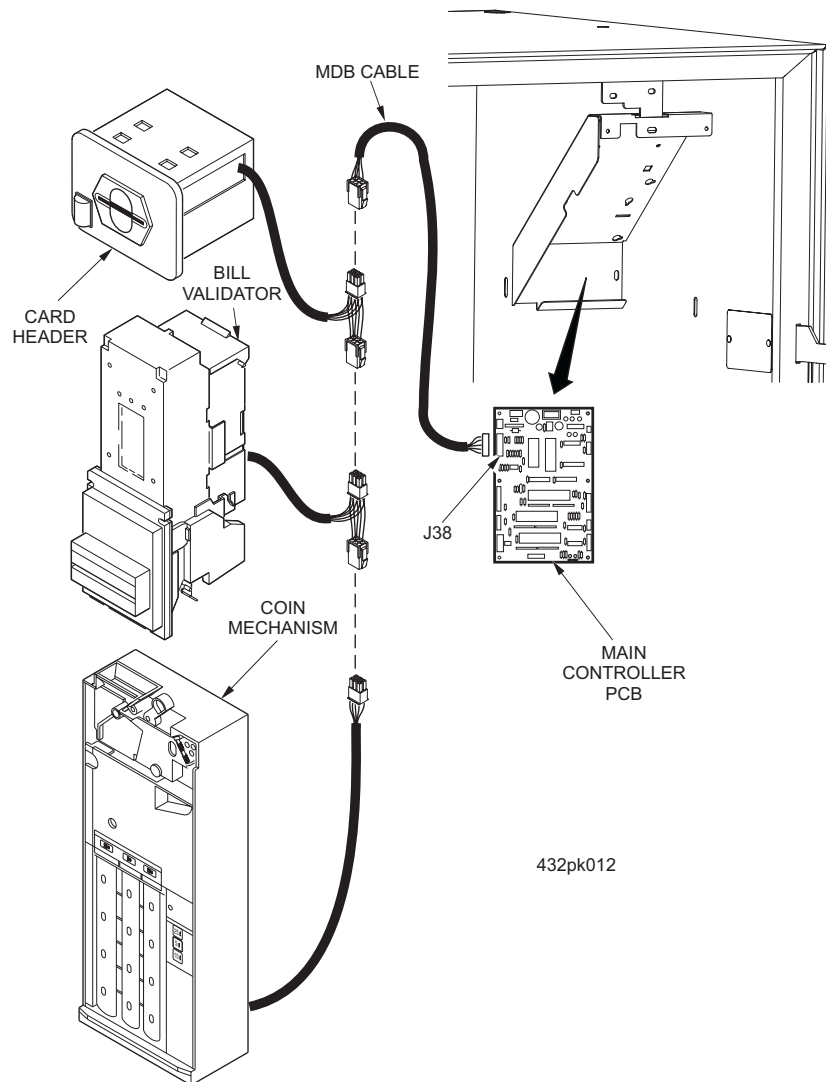

- The following figure shows a coin mechanism, bill validator, and card reader connected to one another with an MDB configuration. Some monetary configurations may not include all of these devices. Connect your coin MDB mechanism as shown:



- Turn ON the main power switch. Select the proper coin mechanism (See “Select Coin Mechanism and Options” on page 31). Press  until the standby message is displayed, then press .
- Insert enough coins through the coin slot into the coin tubes to more than cover the empty sensor. Insert coins one at a time and ensure they lay flat in the tubes. The amount of coins you insert is internally recorded.
- Manually finish filling all the tubes with coins.
- Visually check the coin tubes to make sure coins are not shingled.
- Turn OFF the main power switch.

INSTALL THE DOOR LOCK

There are two optional door locks available from National Vendors:

1. FLEX-ACE (P/N 9992002)
 - Corresponding key (P/N 9994002)
 - Lock and (2) key kit: (P/N 1670709)
2. VAN LOCK (P/N 3112163)
 - Corresponding key (P/N 3112164)
 - Lock and key kit (P/N 4750702)

Install the door lock cylinder:

1. Insert the key into the lock cylinder and turn it to retract the latch pin.
2. Press the latch pin until it is flush with the cylinder, and slide it into the lock until it clicks into place.

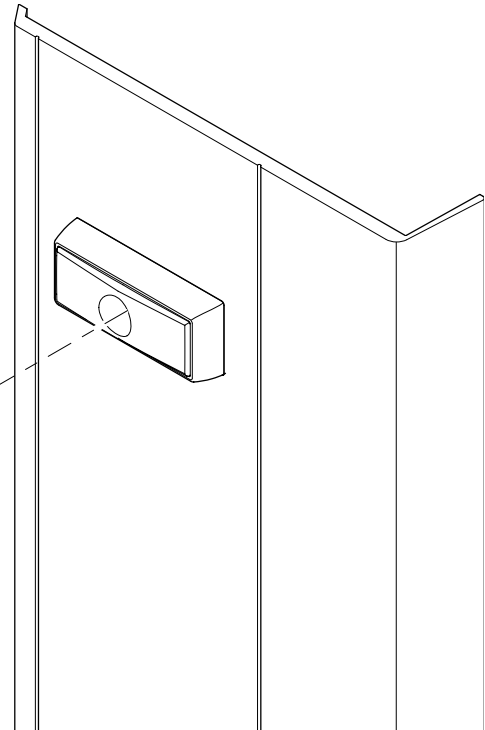
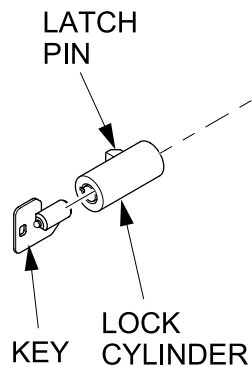

432pk017

NOTE: If higher security is desired, the standard lock handle can be replaced by higher security bottle/can type locks. These are commonly available through OEM lock suppliers.

INSTALL THE MONEY BOX LOCK

Install the optional money box lock as follows:

1. Remove the money box from the merchandiser.
2. Remove the screw, cam, nut, and washer from the lock assembly.
3. Insert the lock into the opening in the money box. Secure with the washer and nut.
4. Install the cam and secure with the screw.
5. Place the money box back in the merchandiser and test the lock with the key (provided).

NOTE: An optional monetary panel lock is also available as an accessory.

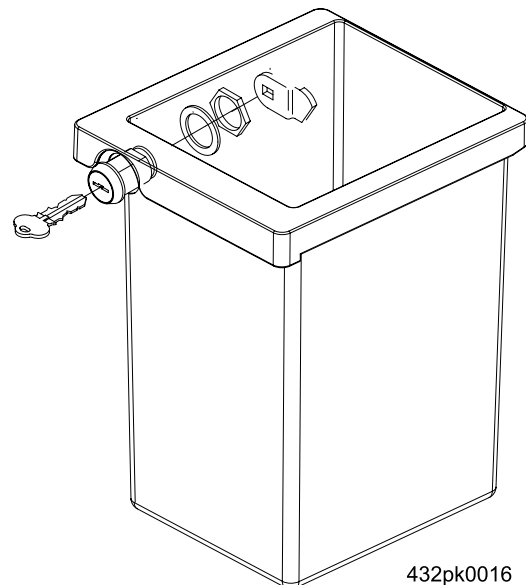

432pk0016

Section 3: Drum and Tray Setup

ADJUST THE PRODUCT DIVIDERS

The drum is divided horizontally into nine levels, and vertically into five zones (see figure below). Each level is divided into five trays, with each tray corresponding to one of the five zones.

A tray can be divided into 1, 2, 3, 4, or 5 compartments. **ALL TRAYS ON A GIVEN LEVEL MUST HAVE THE SAME NUMBER OF COMPARTMENTS.** This means that any given level can have 5, 10, 15, 20 or 25 compartments only.

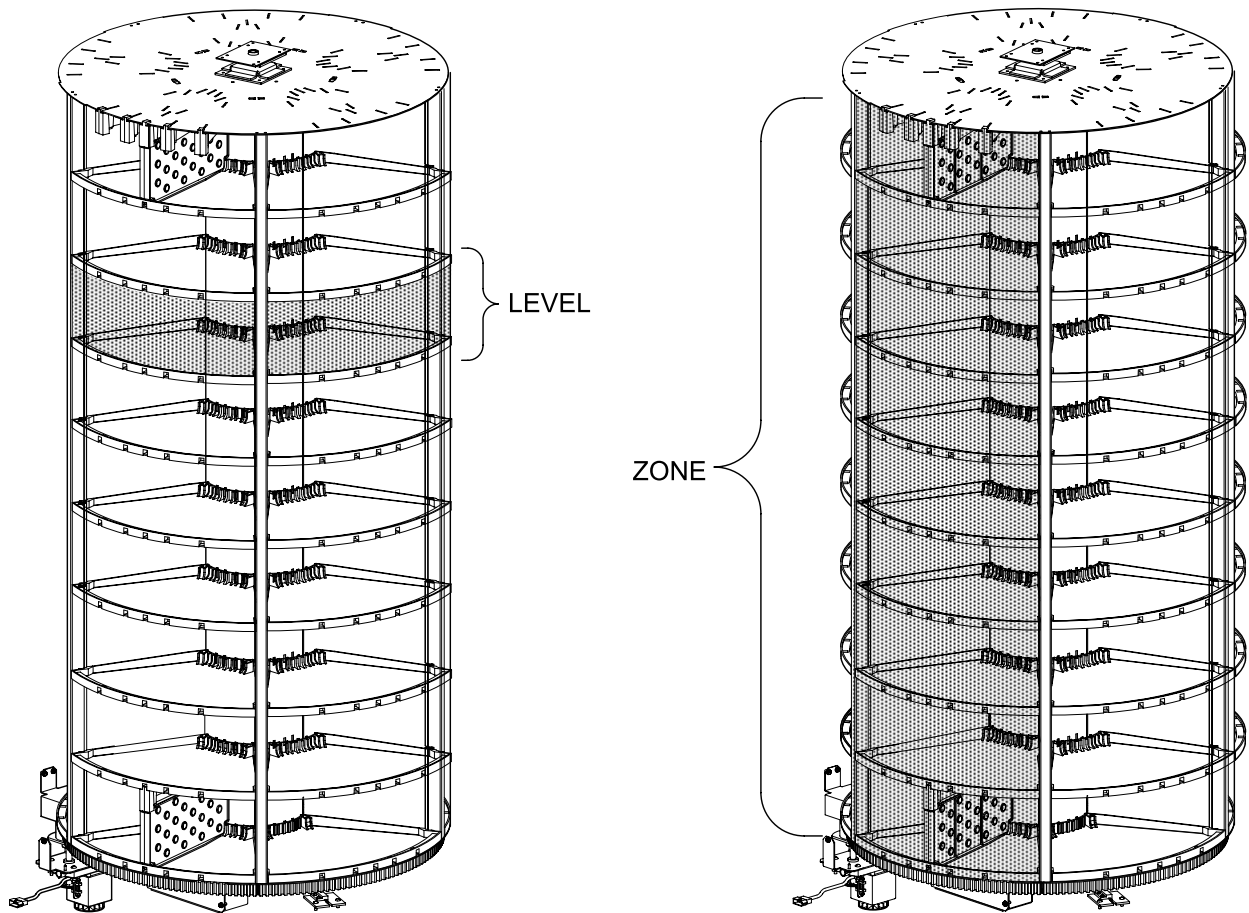

432pk010

Add or remove product dividers to accommodate various size products. One divider will split the tray into 2 compartments, causing the entire level to have 10 compartments total. Two dividers will make three compartments per tray and 15 per level, and so on.

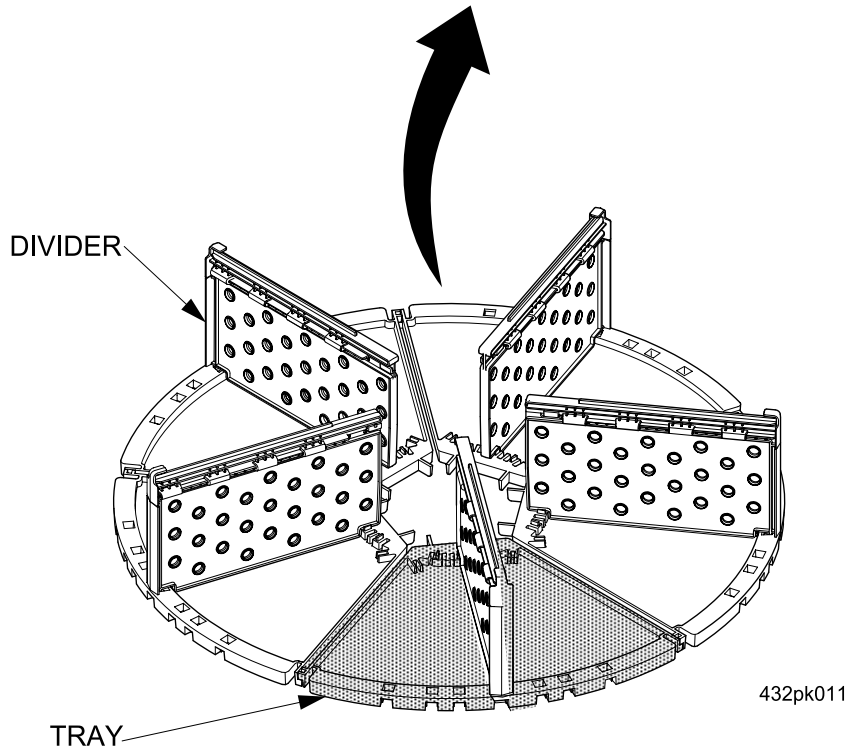
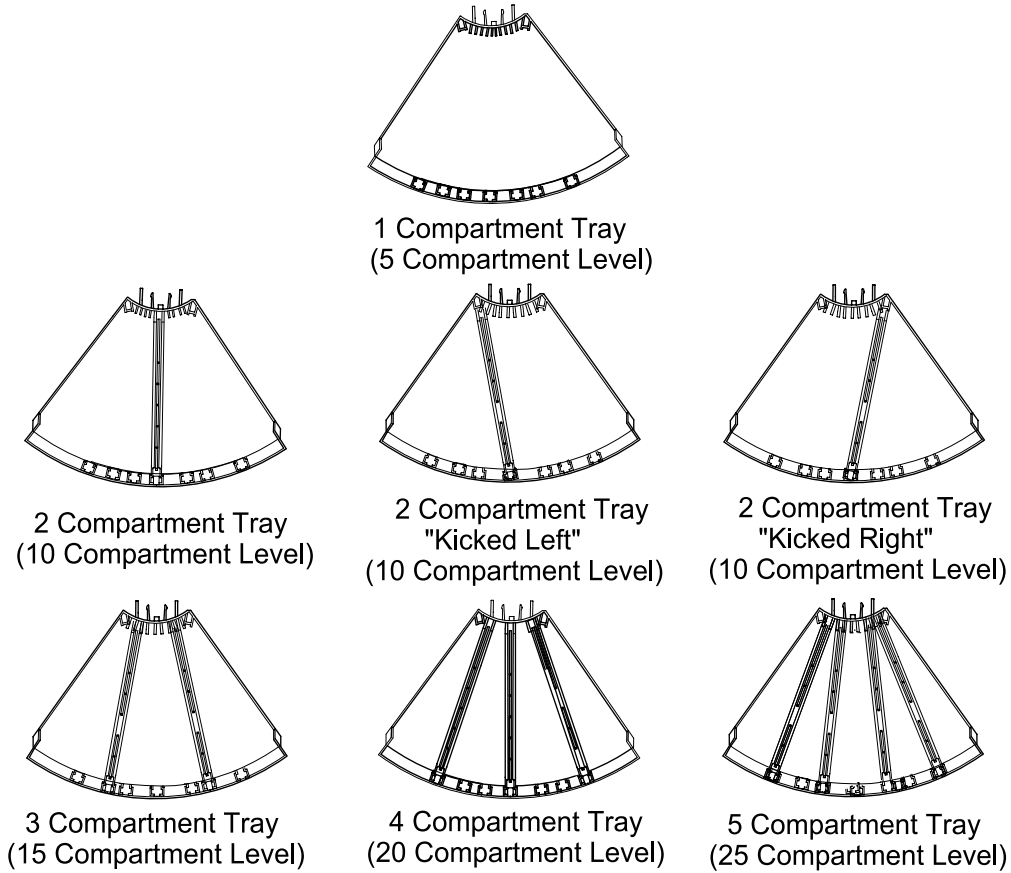

FIGURE 3: VALID DIVIDER SETUPS

ADJUST THE DIVIDERS

IMPORTANT

When adjusting product dividers, make sure that all five trays on each level are set to the same valid divider setup.

EXCEPTION:

Standard 2 compartment trays, "Kicked Left" and "Kicked Right" 2 compartment trays **can** be mixed and matched on the same level.

1. Hold the divider in one hand and firmly grasp the retainer with the other. Slide the retainer out while holding the divider in place.
2. Remove the divider by tilting up the far end, then pushing away to disengage the tab.
3. Place product dividers in the tray in the new configuration. Notice how the trays have channels for the retainer to slide into. Use these channels as a guide when you seat the dividers. Also, make sure that only valid divider setups are used (See Figure 3, "Valid Divider Setups," on page 10). Failure to do this will cause inconsistent compartment sizes and may cause vend and tamper check errors.

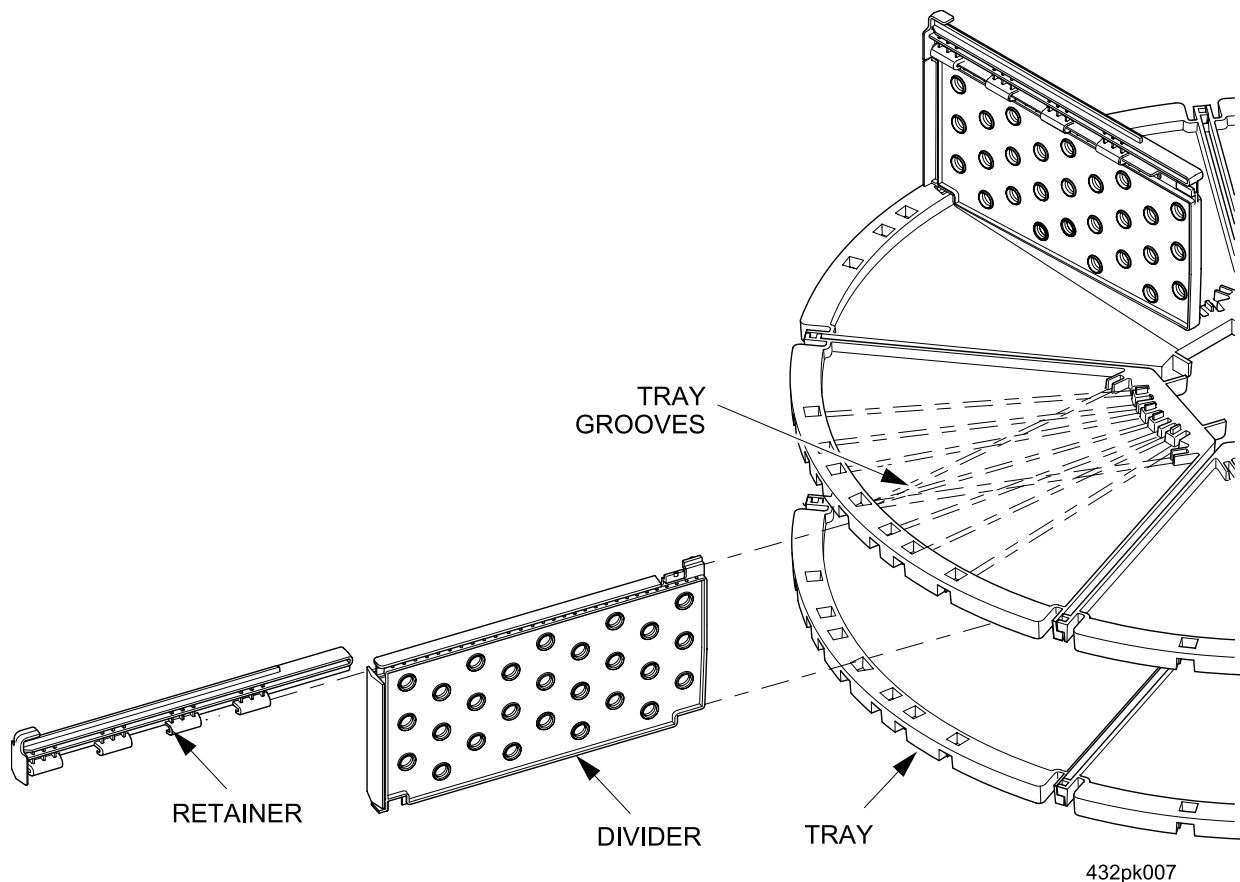

4. Slide a retainer onto each divider until it clicks into place.
5. Program the machine to match the new configuration. See "Set Number of Compartments" on page 37.
6. Adjust the delivery door stops to match the new tray configuration for each level. See "Adjust the Delivery Door Stops" on page 12.

ADJUST THE DELIVERY DOOR STOPS

Once the shelf dividers for each level are set, you need to configure the door stops so that the vend doors will open the correct distance. Each delivery door has a door stop mounted on the vend door guide. When the door stop is adjusted correctly, the vend door will open wide enough for the customer to remove only one product.

1. Open the cabinet door. The Vend Door Guide (p/n 4322051) for each level has five recesses sized to seat the Vend Door Stop (p/n 4322053) using Phillips screws.
2. Place the door stop in the desired position (see figure below) and secure it with the stop screw. Use a Phillips screw and door stop (p/n 4322053) or damage to the merchandiser may result. Do **NOT** overtighten screws.

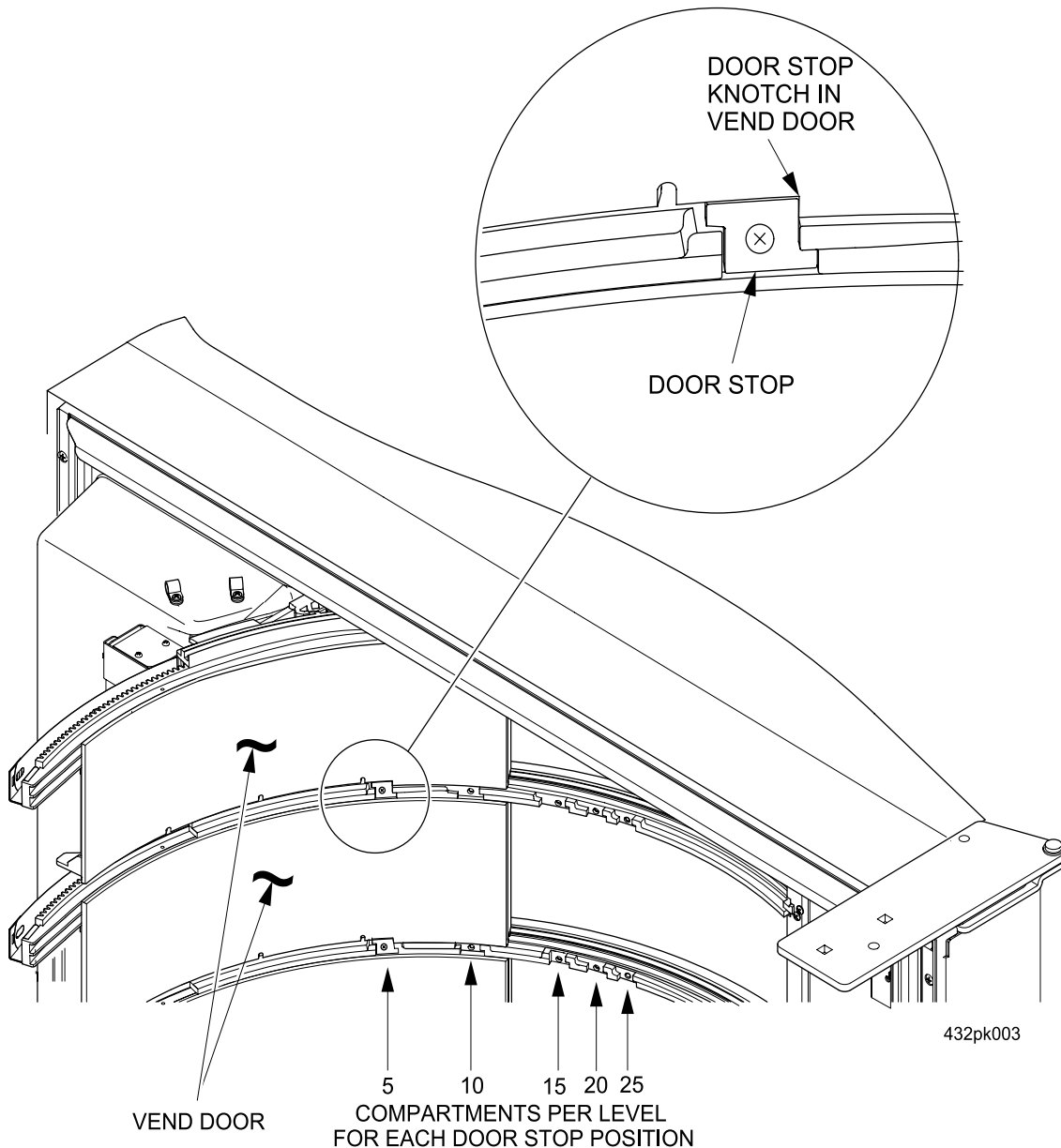

- Place the door stop in the first recess for a five compartment level. Use recess 2 to set the door stop for 10 compartments per level, use recess 3 for 15 compartments, etc.
Note: Four replacement stops and stop screws are provided in the topmost door track.



IMPORTANT NOTE:

Whenever you adjust the door stops, ensure that the stop position for each level matches the number of compartments on that level. If the stops are not configured correctly, the door may open too wide, granting access to more than one compartment per vend, or the door may not open wide enough for the customer to retrieve their purchase.



SHELF ASSEMBLY REMOVAL AND REPLACEMENT

- Rotate the drum until the shelf to be removed is directly in front.
- Remove dividers, if applicable. See "Adjust the Product Dividers" on page 9.
- Remove the screws and rails on both sides of the shelf.
- Slide out the shelf assembly.
- Replace the shelf by performing steps 1 through 4 in reverse order.

VEND DOOR REMOVAL AND REPLACEMENT

- Press  then  until the display shows *SOL TEST*. Slide the vend door that will be replaced. The door solenoid will hold the door unlocked while the vend door is replaced.
- Remove the door stop using a Phillips screwdriver.
- Slide the vend door to the left until the end of the door spring can be seen. Disconnect the door return spring. Insert a pocket screwdriver or any other item into the spring hole. This will retain the spring and keep it from rewinding on the spool. (Skip this step if you have motorized vend doors.)
- Slide the door to the left and out of the track. Remove the spring holder from the door and install it on the replacement vend door.
- Slide the replacement door into the track as far as the cam that actuates the micro switch. Push the cam in, towards the switch to allow room for the door to pass. Do not slide the door any further until the return spring has been reattached to the vend door. (Skip this part if you have motorized vend doors.)
- Continue to slide the vend door in until it passes the door lock mechanism held open in step 1. Move the door into the home position.
- Reinstall the door stop using a Phillips screwdriver.

INSTALLING AUTOMATIC VEND DOORS

1. Press  then  until the display shows *SOL TEST*. Slide the vend door that will be removed. The door solenoid will hold the door unlocked while the vend door is being removed.
2. Remove the door stop using a Phillips screwdriver (see illustration, previous page).
3. Slide the vend door to the left until the end of the door spring can be seen. Disconnect the door return spring. Insert a pocket screwdriver or any other item into the spring hole. This will retain the spring and keep it from rewinding on the spool.
4. Slide the door to the left and out of the track.
5. Repeat steps 1-4 until all nine vend doors have been removed.
6. Turn the machine power switch OFF.
7. Remove door heater wires off each door from bus bar.
8. Remove all 9 door guide assemblies.
9. Remove spring and roller assembly from each door guide.
10. Insert bushing in each of the guide rails.

11. Install gear and motor in place of the spring and roller assembly.
12. Install all 9 guide rail assemblies back on the door.
13. Attach all the heater wires on the bus bar.
14. Locate wiring harness for door motors behind solenoid assembly.
15. Wire each door motor up.
16. Slide each door into the track as far as the cam that actuates the micro switch. Push the cam in, towards the switch to allow room for the door to pass.
17. Continue to slide each vend door in until it passes the door lock mechanism held open in step 1. Move the each door into the home position.

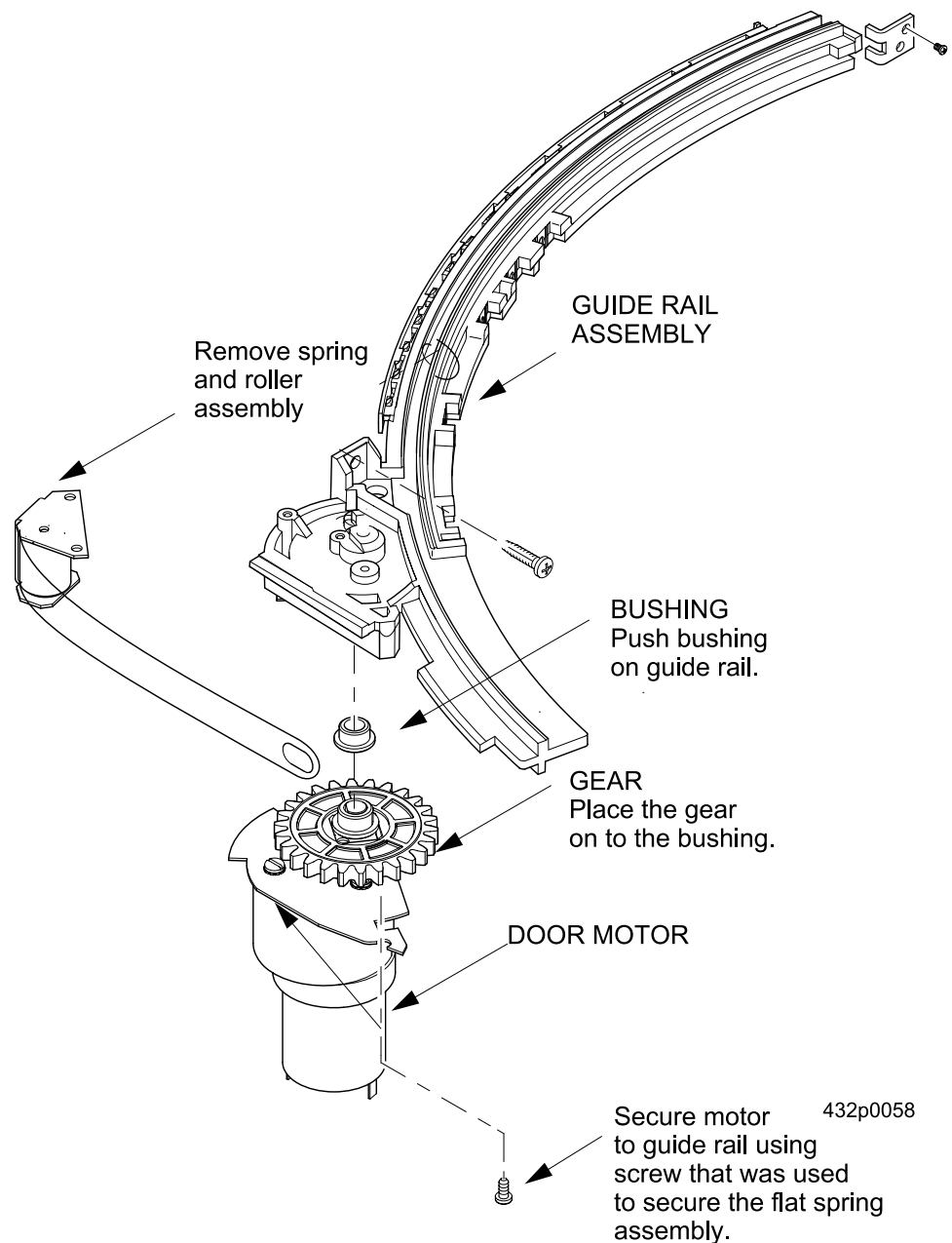

18. Reinstall each of the door stops using a phillips screwdriver.
19. Power machine up and make sure all vend doors go through auto-directional test.

OPERATING AUTOMATIC VEND DOORS

1. Insert correct amount of money for selection.
2. Pull on door until the door switch is made.

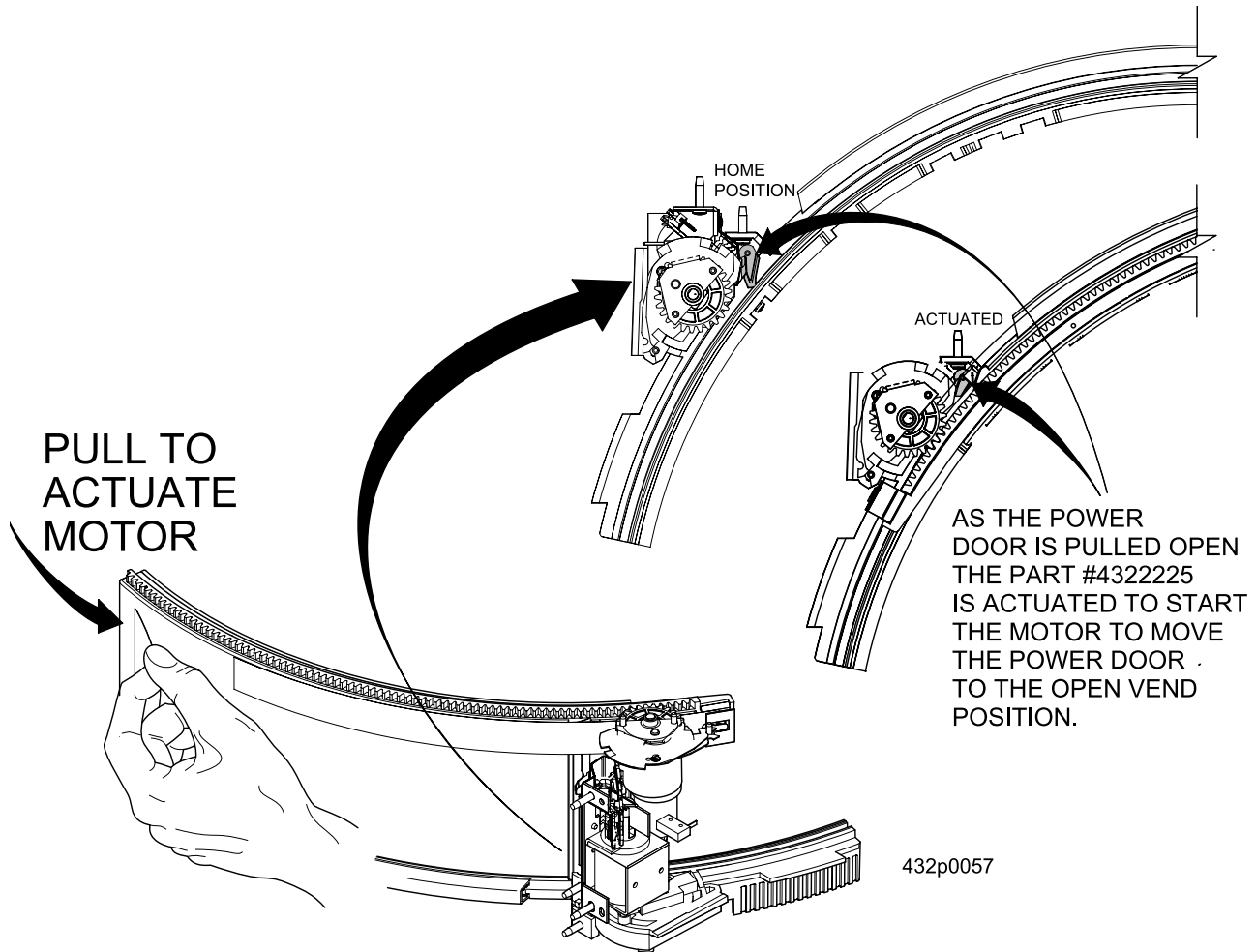

3. Once credit is verified and door switch is made, the lock solenoid will then unlock the door.
4. When the solenoid unlocks the door the door motor will then start.
5. If an obstruction prevents the door from opening a reasonable amount, the door will close at a distance and try to re-open a maximum of 10 times. After 10 failed attempts to open the door, the door is the considered failed and a non-fatal error is set.
6. The door will then open until it reaches the door stop and then will stop.
7. The door will then stay open for a predetermined time (default is 5 seconds).
8. The door motor will close the door until it reaches the door switch.
9. If after opening, an obstruction prevents the door from closing completely, the door will re-open and try to close a maximum of 10 time. After 10 failed attempts to close the door, the door is the considered failed and a non-fatal error is set.
10. The door will then try to close again in about 5 minutes.

ADJUST THE STOP PIN

1. Turn the machine power switch OFF.
2. Remove cover.
3. Loosen the four screws that locate the solenoid housing to the bracket.
4. Make sure the stop pin is seated in a hole in the drum plate.
5. Push up on the bottom of the housing to raise the assembly to the correct working position. There should be a small gap inbetween the motion sensor and lever as shown below.

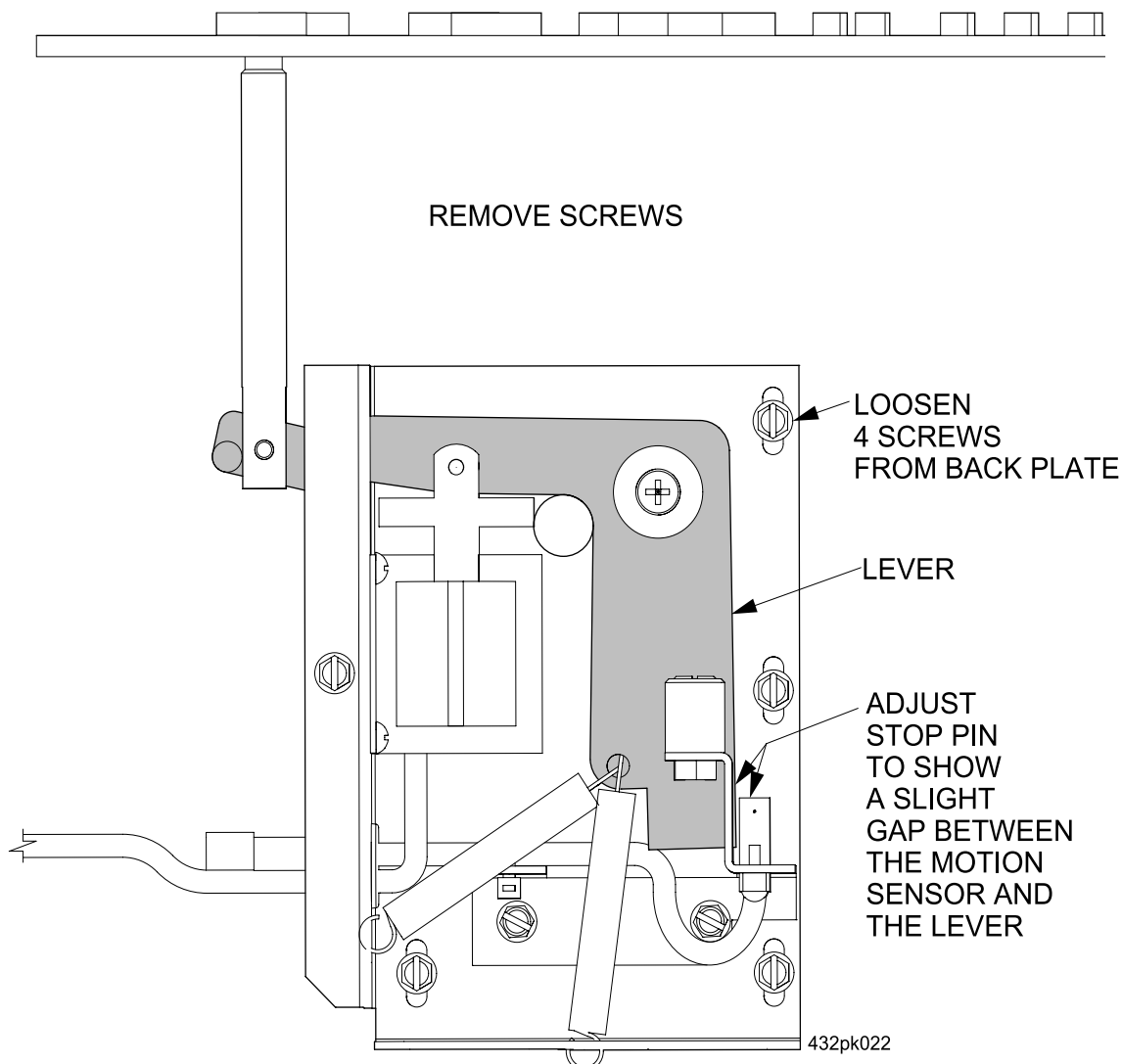

6. Once proper position is found tighten screws that attach the plate to the stop pin housing. Check this adjustment all the way around the drum to ensure proper adjustment.
7. Replace cover.

DRUM ASSEMBLY REMOVAL AND REPLACEMENT

WARNING

The Shopper door is heavy. The cabinet could tip over if the door is open and the drum assembly is removed from the cabinet. Use the support leg or a solid object to brace the end of the door farthest away from the hinges prior to removing the drum assembly from the Shopper cabinet.

1. Loosen the two screws holding the support leg to the door, slide the support leg all the way down toward the floor, then securely re-tighten the screws.
2. Remove any food from the drum assembly.

CAUTION

The EMPTY weight of the food drum is approximately 75 lbs (34.0 kg). Do not attempt to remove or install the food drum without help.

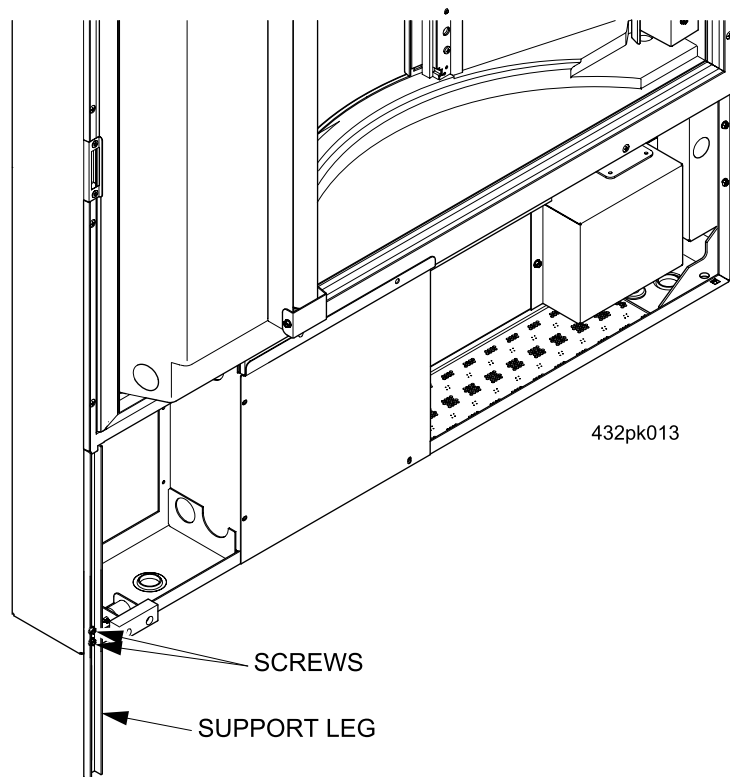

3. Locate the Solenoid Assembly. Clamp or wedge the Stop Pin Lever Arm in the down position so that the stop pin clears the bottom of the turret.

OR

Remove the solenoid assembly cover, loosen the four screws holding the solenoid in place, and lower the solenoid until the stop pin clears the bottom of the turret (See "Adjust the Stop Pin" on page 17).

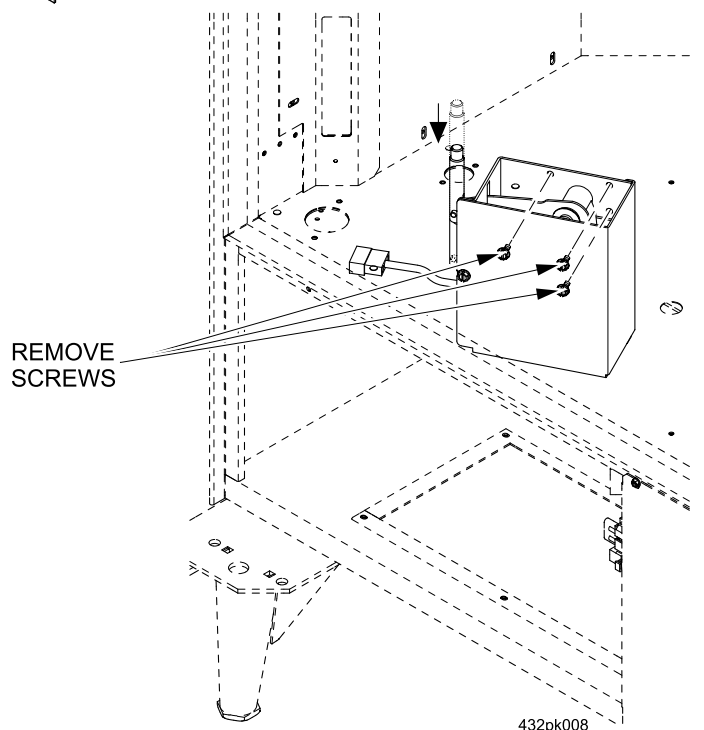

4. Remove the plastic insulation cover and insulation from the bottom of the drum.

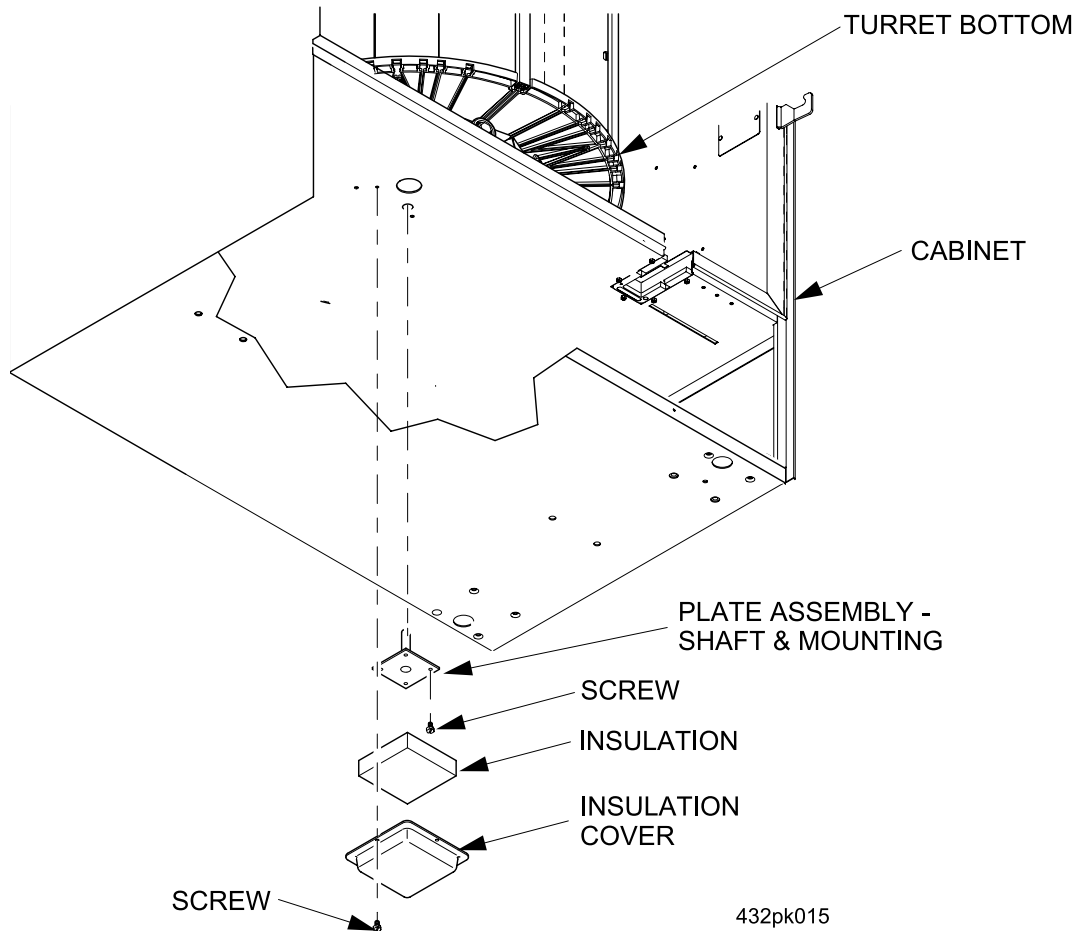

5. Remove the four (4) screws securing the Plate Assembly - Shaft & Mounting (p/n 4327023) to remove it.

6. Remove the screw (p/n 1451097) securing the Turret Latch Arm (p/n 4327044).

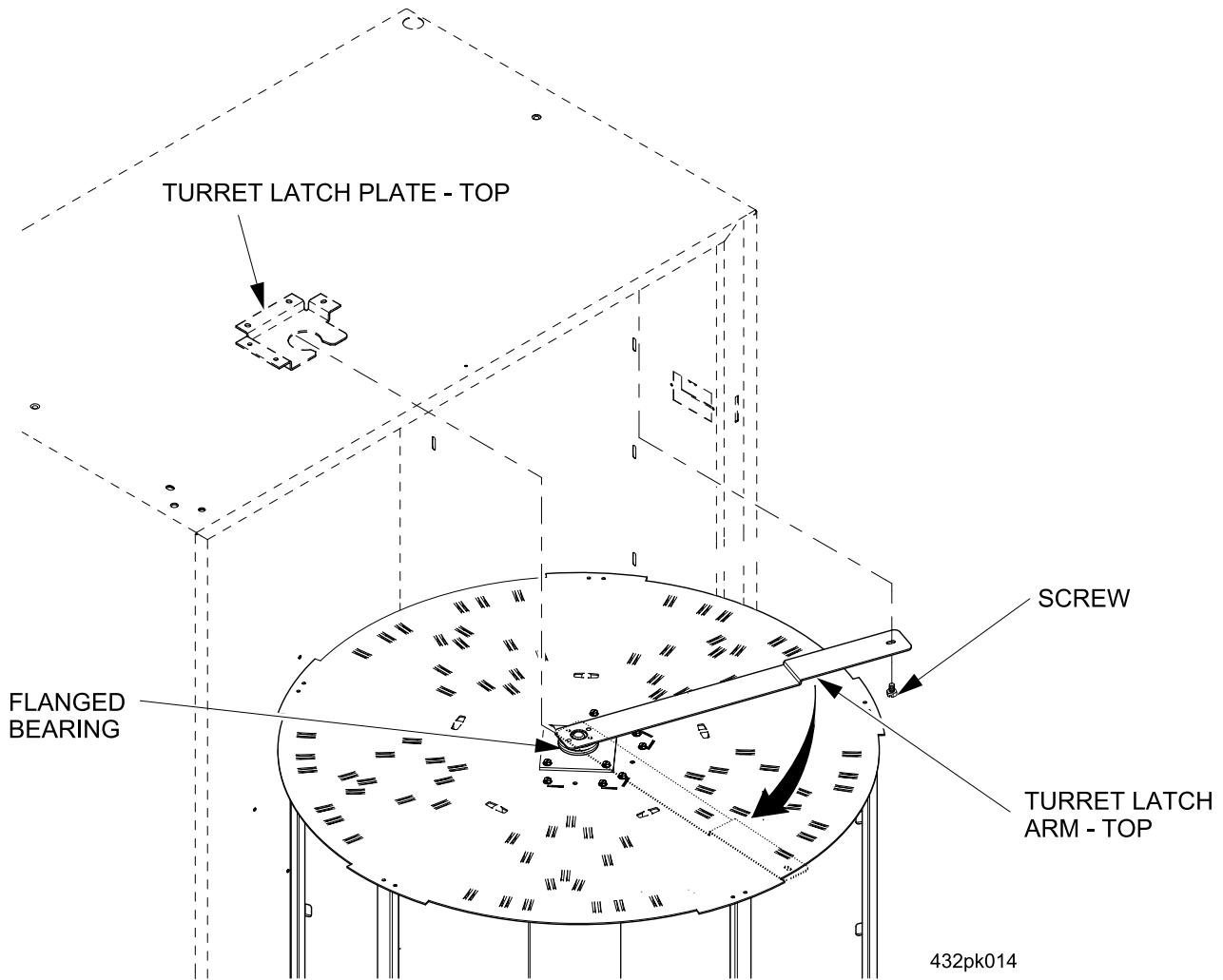

- 7. Rotate the Turret Latch Arm until the top of the drum is free to move forward.
- 8. Carefully slide the drum off of the Latch Plate and lift it out of the merchandiser.

CAUTION

The turret has parts on the bottom that could be damaged by rough handling.

LOAD THE MERCHANDISER

There are two modes of loading: The first is "Full Shop", in which the entire drum is loaded. The second is "Limited Shop", where only two to four zones of the drum are loaded. Limited Shop is usually used in smaller locations where all food in the merchandiser may not be vended before the freshness dates expire (See "Set Shop Zones" on page 37). The general loading procedure is as follows:

1. Adjust the product dividers, if necessary (See "Adjust the Product Dividers" on page 9).
2. Set new prices, if desired (See "Set Prices" on page 54).
3. Set discount prices, if desired (See "Set Time-Of-Day Discount Vending" on page 46).

IMPORTANT

The load switch overrides the Limited Shop mode, and allows an unused zone(s) of the drum to be loaded.

NOTICE

If the drum is loaded with food that is too large for the compartments, the drum will not rotate properly.

4. Push the loading switch plunger until the drum rotates to the zone where you want to load food items, then release the plunger.

NOTE

You can pull out the loading switch plunger and the drum will rotate continuously until you push the plunger into the mid position.

5. Load the zone, then repeat step 4 until the drum is loaded.
 6. Tell the machine that it is full by performing one of the following:
 - a. If Tamper Check is ON, go to "Check for Tampering" on page 41
- or-**
- b. If Tamper Check is OFF, press  until the Standby message displays, then press

and hold  until the display shows *FILLING* and then *FULL DRUM*.

7. Close the refrigeration door.

Section 4: Programming Introduction

Certain setup, test, and maintenance operations are computer controlled. The control panel and the display panel regulate these operations.

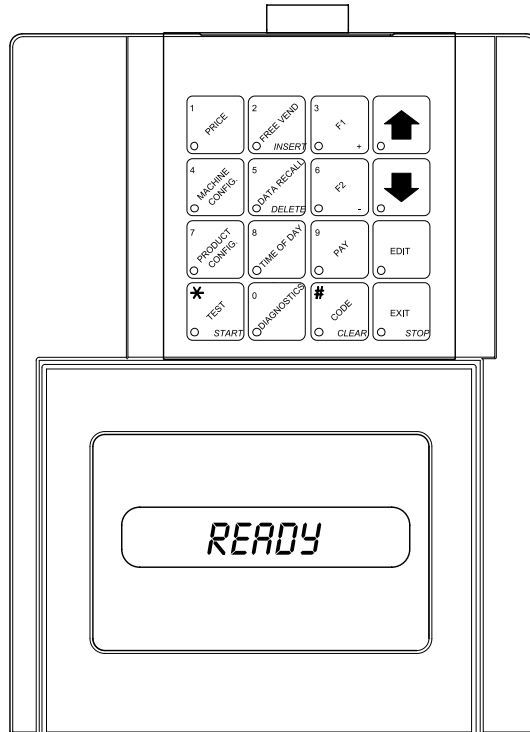

432pk018

Control Panel and Display Panel
(view with monetary door open)

THE DISPLAYS

The 10-character display performs two functions, and is referred to in this book as "the display":

1. It shows the customer's selection and how much credit is in the machine, as well as the ready, service, and time of day messages.
2. It provides information and feedback to the service person during maintenance.

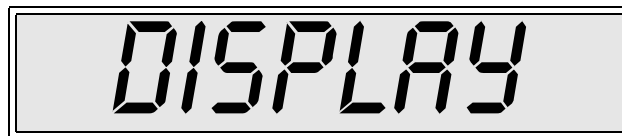

THE FUNCTION KEYS

The keys on the control panel can have up to three uses:

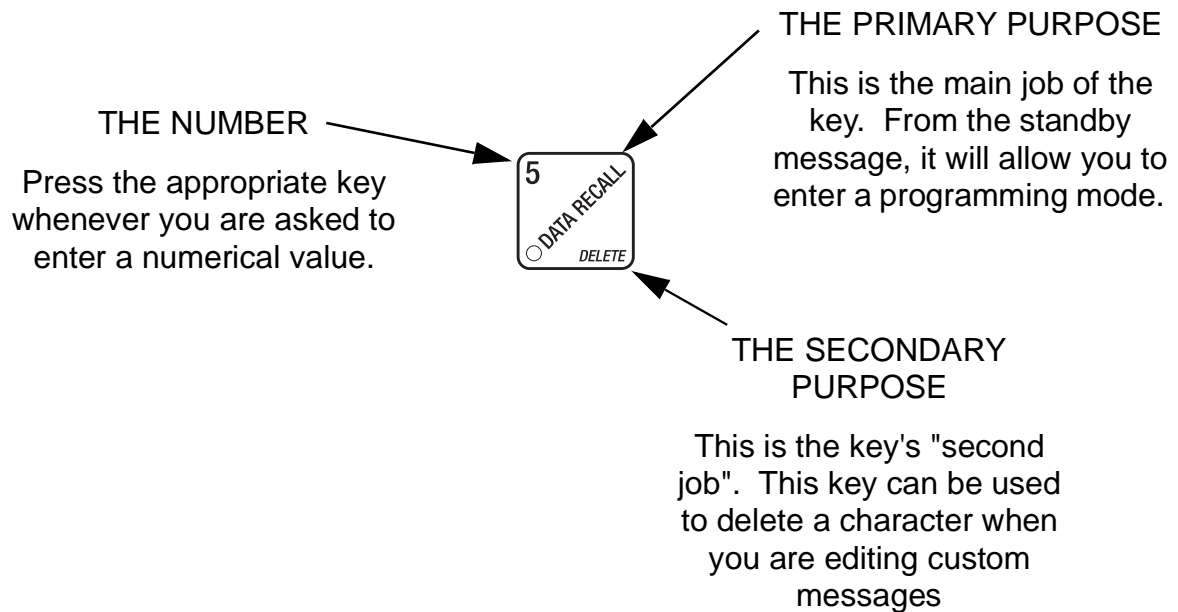

OTHER KEYS

The MOVEMENT keys on the control panel let you move inside a mode, and back and forth between modes. To see how these keys let you move around, study the "Programming Flow Charts" on page 25. (**Warning:** If the vend doors are moved while you are in the programming mode, this may affect your programming settings).



The up and down arrow keys are your "legs", which let you move up and down the list of tasks. These keys are what let you continue from one step to the next in programming procedures.



This is your "activate" or "choose" key. It "opens a door" to additional information and lets you begin a programming task once you are inside of a mode. Sometimes, it is used as a toggle switch to show you your choices during a programming task.



This is your "end" key. Pressing it one or more times will move you back to the start of the mode, or all the way back to the standby message. The last option displayed when this key is pressed will be the selected option.



This key lets you start an action, such as a test.

CONTROL PANEL BUTTONS EXPLAINED



Press this button to put your machine into the Price Setting mode. You can see maximum and minimum machine prices, and change prices for the entire machine, individual levels, or individual selections.



Press this button to set up how the Free Vend mode will operate.



Press this button to view the refrigerated cabinet temperature, software version number, machine and accessory configuration, and active selection status.

Press this button to:



- Select the display language
- Select coin mechanism and options
- Select bill validator and options
- Select card reader and options
- Select monetary options
- Set winner feature

Press this button to:



- View total sales by machine, zone, level, tray, or selection
- View total vends by machine, zone, level, tray, or selection
- View or set machine I.D.
- Clear resettable data
- View time data
- View Winners

Press this button to:



- Download data into your portable data collection device (PDCD), **OR**
- Set printer baud rate, depending upon which device you are using

Press this button to:



- Set which zones are active
- Set number of compartments
- Set drum and door time options
- Turn Tamper Check On/Off
- Set machine temperature
- Set Defrost Options

Press this button to:



- Set time of day
- Set day, month, year
- Set Daylight Savings Option
- Set up time of day intervals for inhibit, freevend, and discount vending
- Edit messages
- Select display messages

Press this button to:



- Pay one or more coins from the coin mechanism.

Press this button to:



- See any fault or condition that has placed the machine out of service (See "View Diagnostic Messages" on page 65).

Press this button to:



- Perform test vends
- Test machine functions
- Test displays

Press this button to:



- Enter the Supervisor mode
- Change the Supervisor access code
- Lock and unlock access to functions
- Set Printer or Dex Options
- Turn Talker Mode On/Off

ONE LAST THING:

When you see the word CONTINUE at the end of a function, it means to press  until you return to the standby message.

PROGRAMMING FLOW CHARTS

After you become familiar with the programming functions, you will be able to perform them without using the detailed, step-by-step tables. The following group of flow charts will give you a quick reference to the functions each key performs. If you need additional information, just refer to the page shown in the chart.

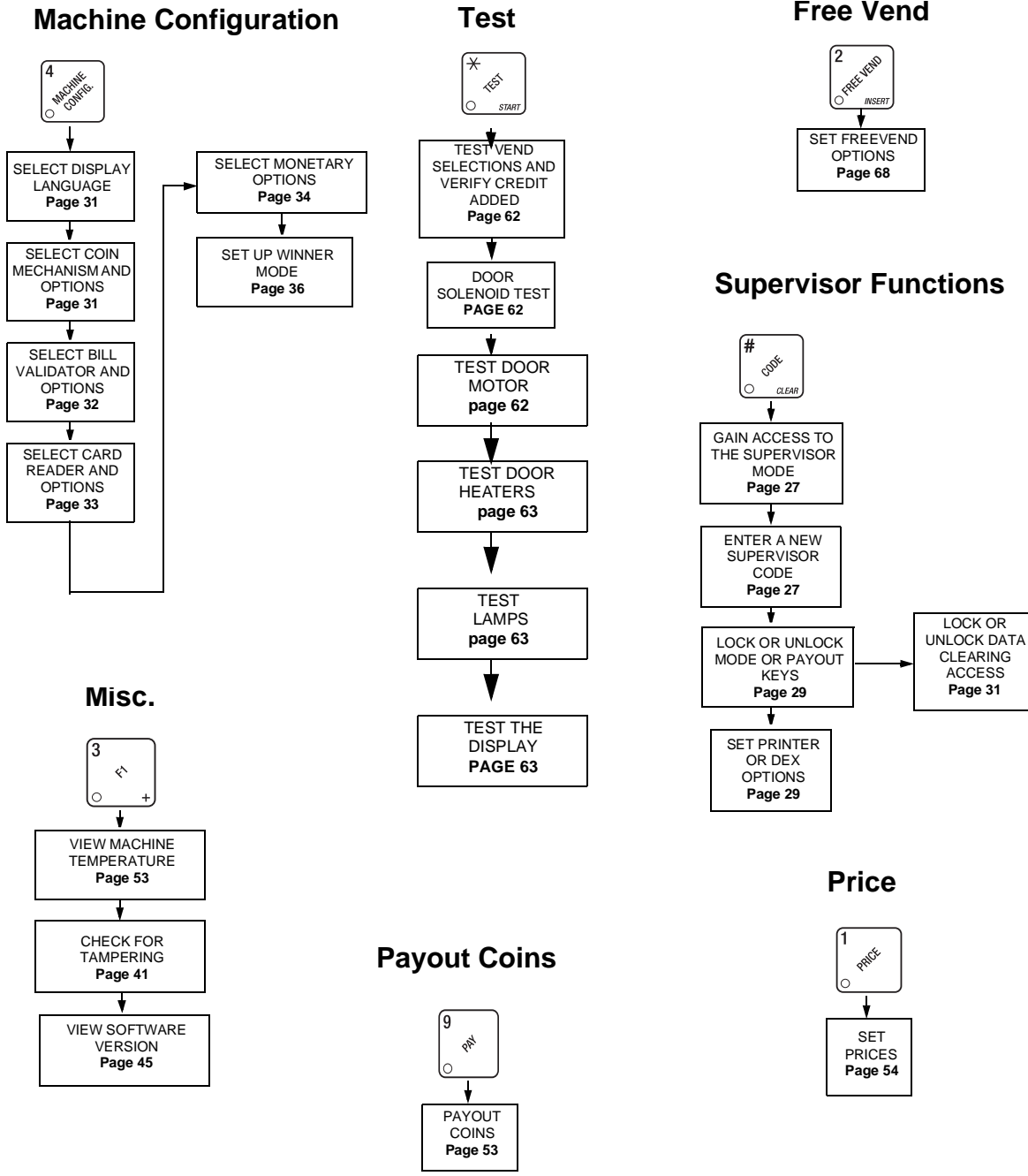

Time of Day

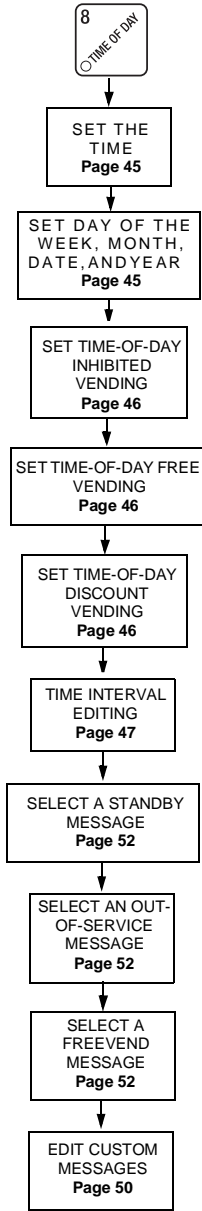

Data Recall

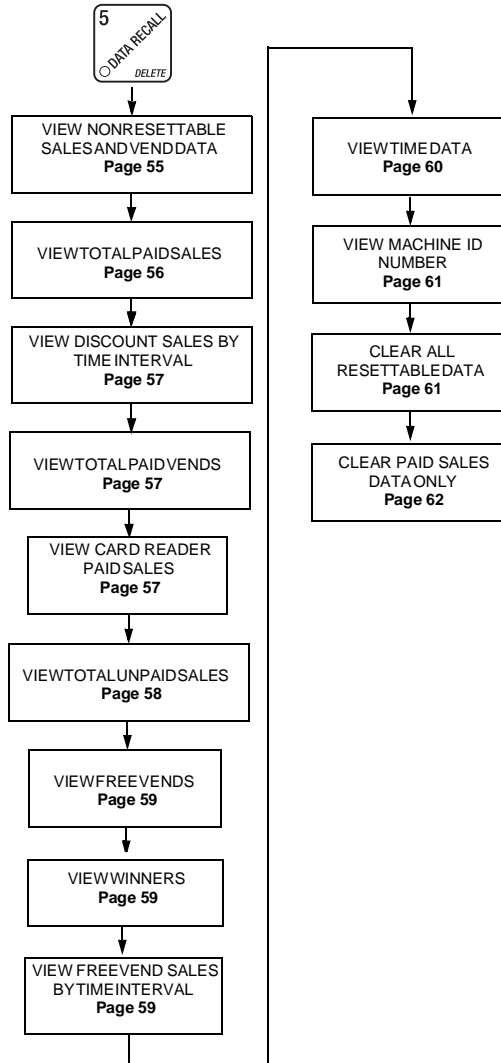

Product Configuration Functions

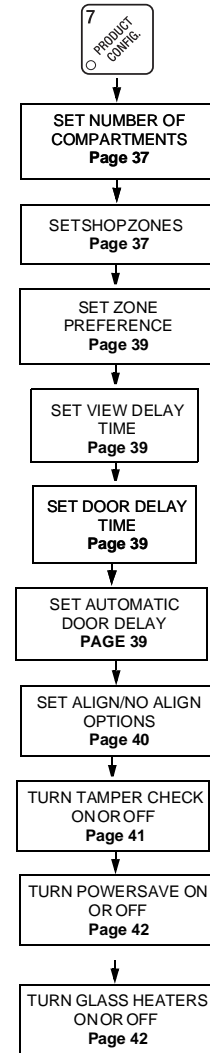

DEX/Printer

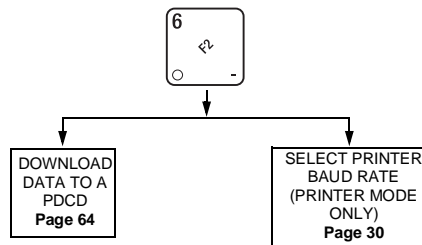

View Diagnostics

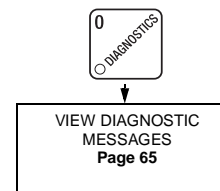

**GAIN ACCESS TO THE SUPERVISOR MODE**



1. Press . The display shows: *ENTER CODE*. You must enter the four-digit supervisor code within 6 seconds to gain access.

NOTE

A new machine has a factory-set supervisor code of 0000.

When you have entered the right code, you will hear two beeps and see *UNLOCKED* in the display. After a few moments, the standby message returns.

**ENTER A NEW SUPERVISOR CODE**

1. Follow the steps in "Gain Access to the Supervisor Mode" on page 27.
2. Press , then  until the display shows *SUPER XXXX*. The X's represent the current supervisor code. Use the number keys to enter a new code.

IMPORTANT!

If you enter a new code, be sure to keep a written record of it. There is no other way to access the SUPERVISOR mode.

3. CONTINUE.



SPECIAL NOTE

If the display shows *FREE 0000*
This is a freevend code that is not applicable to this machine. **DO NOT** enter a number to replace the zeros.



ENTER A NEW DATA RECALL CODE (Supervisor Mode Only)

If the proper non-zero code is entered, sales and non-resettable sales data can be viewed without opening the machine's door.

1. Follow the steps in "Gain Access to the Supervisor Mode" on page 27.
2. Press , then  until the display shows *NR XXXX*. The X's represent the currently entered code. Use the number keys to enter a new code, if desired. Do not use any zeros in the code, as there is no way to enter a zero with the machine door closed.

NOTE:

A code of 0000 disables this feature and is also the default.

Usage:

With the machine in ready mode, enter the 4-digit code by sliding the door of the level that corresponds to the number you wish to enter (the top level is #1, the bottom is #9). For example, to enter 1122, slide the door on the top level twice, then slide the door on the second level twice.

NOTE



The last door you slide must be off-line (in a non-vendable position) for the sales total to display.

When the correct code is entered, the non-resettable sales total is displayed. The machine total will show in the main display, and the dollar total for each level will show in the price displays. To see the exact total for a level, slide a door on that level to the right. The dollar and cents total will show on the main display.

This display will remain active for 9 seconds, or until another key is pressed.

3. CONTINUE.

**LOCK OR UNLOCK MODE OR PAYOUT KEYS**

1. Follow the steps in "Gain Access to the Supervisor Mode" on page 27.
2. Press , then  until the display shows either *#. LOCKED* or *#. UNLOCKED*. The pound sign (#) is the first mode key that can be locked or unlocked. It has a special purpose that is explained in "Lock or Unlock Data Clearing Access" on page 31. To see if another key is locked or unlocked, press that key.
3. Press  to change between locked and unlocked. When anyone other than the supervisor tries to enter a locked mode, the display shows *LOCKED*.



NOTE

The following mode keys cannot be locked out:







4. CONTINUE.

**TURN TALKER MODE ON OR OFF**

1. Follow the steps in "Gain Access to the Supervisor Mode" on page 27.
2. Press , then  until the display shows either *TALK ON* or *TALK OFF*.
3. If your machine has talker hardware, press  to turn talker mode on.
4. CONTINUE.



**SET PRINTER OR DEX OPTIONS**

1. Follow the steps in "Gain Access to the Supervisor Mode" on page 27.
2. Press , then  until the display shows one of the following:
 - PRINTER* - means that data will be sent directly to a printer,
 - DEX ONLY* - means that data remains in memory after it is downloaded into a portable data collection device,
 - DEX +CLR* - means that resettable data is cleared after it is downloaded into a portable data collection device.
 - DEX NR* - a special DEX option. All sales data will become non-resettable. Consult your DEX supplier before choosing this option.
3. Press  to switch between the four choices.

4. If a Dex option is selected, press  until the display shows one of the following two resettable bill validator totals transmitted to the DEX device:
CA 304 = N.O. - the value of bills in the stacker will be transmitted in a cash format.
 For example: 200 for two dollars. (This is the default setting.)
 - OR -
CA 304 = N.C. - the value of bills in the stacker will be transmitted in a dollar count format.
 For example: 2 for two dollars.
5. Press  to switch between the two choices. Consult your DEX handheld supplier for the proper settings for your machine.

NOTE



If your bill count is incorrect, the CA304 setting may be wrong.
 Try using the other setting.

6. Press  until the display shows one of the following two date/time options:
LASTVND.ON - the DEX device will transmit the date and time of the last vend for each selection.
 - OR -
LASTVND.OFF - the DEX device will NOT transmit the date and time of the last vend for each selection. (This is the default setting)
7. Press  to switch between the two choices.
8. CONTINUE.







SELECT PRINTER BAUD RATE (PRINTER MODE ONLY)

BAUD RATE	The speed of data transfer, expressed in bits per second. Your printer can receive data at a certain rate, and you must tell the printer what that rate is.
------------------	---

1. Press . One of the following is displayed:
BAUD 1200, BAUD 2400, BAUD 4800, BAUD 9600
2. Press  until the correct baud rate for your printer is displayed.
3. CONTINUE.

**LOCK OR UNLOCK DATA CLEARING ACCESS**



1. Follow the steps in "Gain Access to the Supervisor Mode" on page 27.
2. Press , then  until the display shows either *#. LOCKED* or *#. UNLOCKED*.
LOCKED means that non-supervisors cannot clear resettable machine sales and vend data from the  key.
3. Press  to switch between *#. LOCKED* and *#. UNLOCKED*.

NOTE



The supervisor can clear data regardless of this setting, provided the supervisor code was correctly entered first.

4. CONTINUE.

**SELECT DISPLAY LANGUAGE**

1. Press . The current **LANGUAGE** is shown in the display. Press  to choose the desired language. Your choices are: *ENGLISH, DEUTSCH, FRANCAIS, ESPANOL, PORTUGUES, SWEDISH, NEDERLANDS*, or *FINNISH*.
2. CONTINUE.

**SELECT COIN MECHANISM AND OPTIONS**

1. Press , then press  until the current **COIN MECHANISM** is shown in the display. Your choices are:
DUMB MECH, MDB MECH, EXEC MECH, or *NO MECH*
2. Press  to choose the desired coin mechanism.



NOTE

Choose EXEC MECH even if the exec device is a card reader. If you selected NO MECH, go to step 3.



3. CONTINUE.



SELECT BILL VALIDATOR AND OPTIONS









1. Press , then press  until one of the following is displayed:

- NO DBV* - No bills will be accepted or there is no bill validator installed (you can exit the function).
- SER.1.2.5.10.20* - The serial bill validator is selected and will accept \$1, \$2, \$5, \$10, and \$20 bills. Use BILL SELECTION METHOD below to change the bills that will be accepted.
- MDB.1.2.5.10.20* - A standard MDB bill validator is selected. It will accept \$1, \$2, \$5, \$10 and \$20 bills. Use BILL SELECTION METHOD below to change the bills that will be accepted.
- PULSE DBV* - The pulse bill validator will accept \$1 bills.
- MDB. (*)* - An MDB bill validator that accepts non-standard bills or tokens is connected and operating. Press  to enter list of bills. (See "Initial Setup of a Non-Standard Bill Validator" on page 33).

BILL SELECTION METHOD: The standard \$1, \$2, \$5, \$10, and \$20 bills are enabled by pressing the 1, 2, 5, 6, or 7 key(s), respectively. Press  to select all denominations, press  to deselect all.

- 2. Press  to choose the desired option.
- 3. CONTINUE.

**INITIAL SETUP OF A NON-STANDARD BILL VALIDATOR**



1. Connect the bill validator, and follow the steps in "Select Bill Validator", to select *MDB.12.5.10.20* in the bill validator selection screens. *MDB.<*>* will not be an option yet.
Exit the bill validator setup by pressing . Bill information is now collected from the validator.
2. Press , then press  until *MDB.<*>* displays.
3. Press . *1 100 ON* will display. The first number (*1*) indicates bill validator channel 1, the *100* is the bill denomination, and *ON* indicates that the validator will accept \$1.00 bills.
4. Press  to toggle the bill acceptance *ON* or *OFF*.
5. Press  and  to scroll through the list of other denominations and to set them to *ON* or *OFF*.
6. Press  to move up to the top level screen.

NOTE

If a denomination does not display in the scroll list of available denominations, check the binary switch settings for the validator. If the binary switch for a given denomination is set to "off", it will not display in the list of denominations.



7. CONTINUE.

**SELECT CARD READER AND OPTIONS**

1. Press , then press  until the current card reader is shown in the display.
2. Press  to cycle through the card reader options.
Your choices are: *NO CARD*, *DUMB CARD*, or *MDB CARD*.

NOTE

If you selected *NO CARD* you can exit the function.

3. Press  until one of the following is displayed:
REVALUE.ON - Allows credit to be transferred onto the card
REVALUE.OFF - Credit cannot be transferred to the card
4. Press  to display the desired choice.
5. CONTINUE.



SELECT MONETARY OPTIONS

This function lets you:

- Set declining balance,
- Set currency acceptance on low change,
- Set overbuy options,
- Set last bill stacking options

DECLINING BALANCE: Once credit is established, multiple vends may occur until the coin return is pressed.

1. Press , then press  until the display shows *CHANGE X.XX*.



X.XX represents the largest denomination coin or bill that will be changed without a purchase. Any non-zero value here will return all escrowed coins. (Each coin denomination for which the coin mech has a tube is called an **ESCROWED** coin because it can be returned.) When the coin return button is pressed, all coins inserted will be returned provided there is a coin mech tube for each of those coins, **EXCEPT** in the forced vend mode.

Some examples:

CHANGE 0.00 - Forced vend; NO change returned without a purchase.

CHANGE .25 - Returns change without purchase if all accepted coins are less than .25 denomination or have a payout tube. Acceptance of a dollar coin will not cause a Force Vend if the coin mechanism has a dollar coin payout tube. Otherwise, accepting a dollar coin or accepting and stacking a dollar bill will cause a Force Vend.

CHANGE 1.00 - Bills and non-escrowed coins less than or equal to \$1.00 will be changed without purchase. All escrowed coins are returned.

2. Press  to display the desired choice.
3. Press  until one of the following is displayed:

ACC <\$\$ X.XX -Accept any bill of value \$X.XX or less. Hold the last bill that meets or exceeds maximum price in escrow.

OR

ACC.STK X.XX -Accept any bill of value \$X.XX or less. Immediately stack the last bill.

Example: If setting is *ACC.STK 1.00* and maximum price is \$1.50. This setting will immediately stack the second \$1.00 bill inserted.

4. Press  to display the desired choice.

5. The value of "X.XX" has two purposes:
- It tells the machine how large a bill or coin to accept even though there is not enough change in the coin mech to cover all possible paybacks.

For example, enter 1.00. The machine will take a dollar bill or coin even though there is less than \$1.00's worth of change. Entering 5.00 tells the machine to take a five even though there is less than \$5.00's worth of change, and so forth.

NOTE

This could cause a customer to be short-changed.

Entering **0.00** means that bills or coins will only be accepted if there is enough change to cover them.

- The value of "X.XX" also tells the machine how much the customer is allowed to overbuy a product. The customer will be short-changed when an overbuy occurs.
Example: For a value of \$0.25: if there is no change in the machine and the customer inserts a \$1.00 bill. The customer can purchase a product for \$0.75 even though the change cannot be paid back. The customer will be short-changed. Normally a purchase will not be approved unless all change can be paid.

Entering 0.00 means that the vend will only be approved when the correct change can be returned (overbuy disabled).

6. Press  until the display shows: *LOW.MSG X.XX*. The display will show *USE EXACT CHANGE* when the amount of available change in the coin mechanism falls below the value of "X.XX". Enter a value with the number keys. For example, if *LOW.MSG 1.00* is displayed, the *USE EXACT CHANGE* message is displayed when less than a dollar's worth of change is in the coin mechanism.

7. Press  until one of the following is displayed:

DECLINE.ON - More than one vend is allowed, with a declining balance.

DECLINE.OFF - A declining balance is not allowed.



8. Press  to display the desired choice.

9. CONTINUE.



SET UP VEND FAIL CREDIT OPTION

The customer can either receive a credit or a refund in the event of a vend failure.

1. Press , then press  until the display shows one of the following:

FAIL - CREDIT - Credit is established if the vend fails.

FAIL - CASH - The customer receives a refund if the vend fails.



2. Press  to choose between the two options.

3. CONTINUE.



SET UP WINNER MODE

WINNER At preselected intervals, a customer may receive a refund for a selection. You can select the intervals and qualifying selections.

1. Press , then press  until one of the following is displayed:

WINNER OFF Winner function is disabled.

OR

WIN XXX Winners are allowed at certain intervals, represented by "XXX".

2. Press  to display the desired choice.



If you selected *WINNER OFF*, you can exit the function.

3. If the display shows *WIN XXX*. XXX represents the number of vends that must occur per each winner vend. For example, an interval number of 50 means that a winner can happen any one time during the next 50 vends. Using the number keys, enter an interval number between 10 and 9999.
4. You can limit what selections are eligible for a winner mode by *ZONE*, by *LEVEL*, by *TRAY*, by *EACH* (compartment), or *ALL* (the entire machine).

- a. To limit winners to a specific **ZONE**, press  until *ZONE* displays. The price displays will show something like *0.1111*. The short lines indicate the number of compartments per tray on that level, and that they are not configured for winner mode. Rotate the drum so that the zone you prefer is in the vend position, then slide any vend door in that zone that is in a valid vend position. You will hear a beep and the price displays will change to something like *4.1111*. The tall lines indicate that all compartments in the zone are configured for winners. To activate more than one zone for winners, rotate the drum so a new zone is in the vend position and slide a vend door in that zone.

- b. To limit winners by **LEVEL**, press  until *LEVEL* displays. The price displays will show something like *0.1111*. Make sure the vend door on the level you prefer to allow winners on is in the vend position and slide the door. A beep will sound and the price display for that level will change to something like: *4.1111*. Slide vend doors on additional levels to activate more than one level for winner mode.

- c. To limit winners by **TRAY**, press  until *TRAY* displays. Rotate the drum until the tray you prefer is in the vend position, and slide the vend door in that tray. A beep will sound and the price display for that level will change to something like: *4.1111*. Slide vend doors in additional trays to activate multiple trays for winner mode.



- d. To limit winners to individual **Selection(s)**, press  until *EACH* displays. The price displays will show something like *0.1111*. Slide the vend door of the selection you wish to allow winners on. A beep will sound and the price display will change to *1.1111*. This indicates that only the second compartment of this four compartment tray is available for winner mode. Slide vend doors to additional compartments to activate multiple selections.
- e. To activate winners for **ALL** selections, press  until *ALL* displays. Slide any vend door that is in a valid vend position. A beep will sound, indicating that the entire machine is configured for winner mode.

5. CONTINUE.



SET SHOP ZONES

You have the option of locking out 1, 2, or 3 zones. In low volume locations, this feature enables an operator to stock only the zones that will sell.

1. Press . Press  until the display shows one of the following:

SHOP ALL - Entire drum is available.

SHOP 1 - 2 - Zones 1 and 2 are available (zones 3, 4, & 5 are locked out).

SHOP 1 - 3 - Zones 1, 2, & 3 are available (zones 4 and 5 are locked out).

SHOP 1 - 4 - Zones 1, 2, 3, & 4 are available (zone 5 is locked out).

2. Press  until the shopping configuration you want is displayed.

3. CONTINUE.



SET NUMBER OF COMPARTMENTS

Each level has five trays (one for each zone). Each tray can have 1 to 5 compartments, allowing the machine to vend 5, 10, 15, 20, or 25 products per level. Remember that **ALL TRAYS ON A GIVEN LEVEL MUST HAVE THE SAME NUMBER OF COMPARTMENTS.**

In order to properly rotate the drum and reliably vend products, the machine must know how many compartments are on each level. Make sure the numbers you enter agree with the actual physical configuration of the compartments. If not, the drum will not stop at the proper location, nor will the tamper check feature work properly.

The following example demonstrates how to set up level 4 to have 3 compartments per zone (giving level 4 a total of 15 compartments).

1. First, make sure the physical configuration is established by correct placement of tray dividers (See "Adjust the Product Dividers" on page 9) and door stops (See "Adjust the Delivery Door Stops" on page 12).

2. Press  .

The display shows
TRAYS (1 - 5).
The price displays will show something like 4.1111.

3. Enter the number 3 on the maintenance keypad, then slide the delivery door on level 4 to the right. The price display at level 4 shows 3.1111.

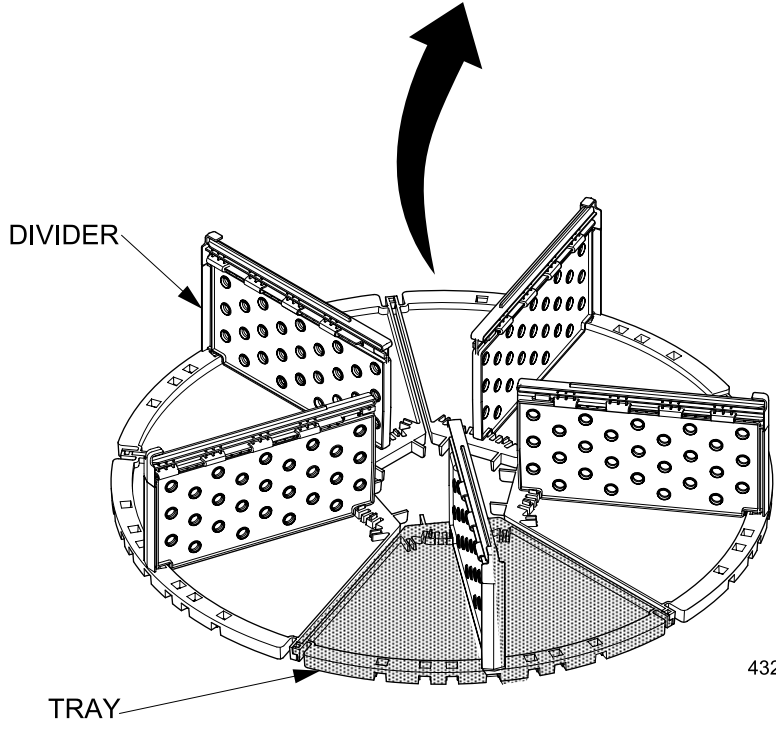
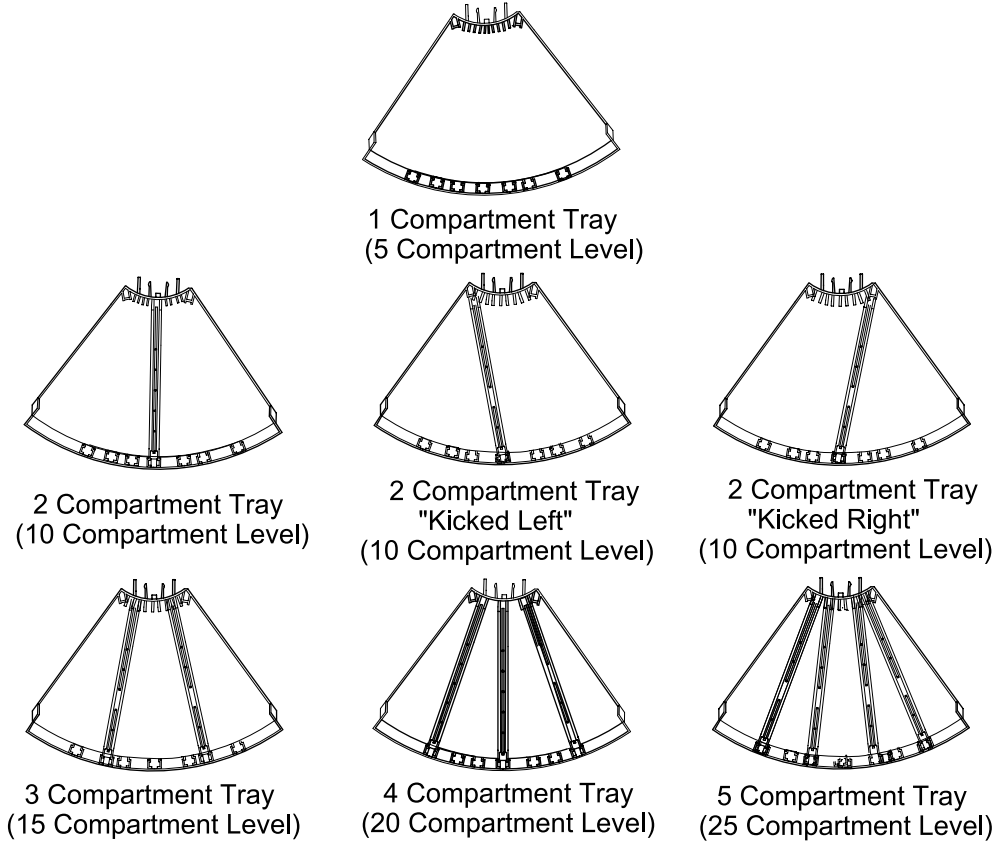

4. CONTINUE.



432pk011



**SET ZONE PREFERENCE**

You can select one of three drum movements to occur after a vend:

1. Press , then  until the display shows one of the following:
PREFER. 1-2 - The drum centers between zones 1 and 2 after a vend.
PREFER. MAX - The drum rotates to the fullest zone after a vend.
NO PREFER - The drum centers itself on the present zone after a vend.
2. Press  until the zone preference you want is displayed.
3. CONTINUE.

**SET VIEW DELAY TIME**

After a vend, the drum will remain stationary for a preset amount of time before rotating:

1. Press , then  until the display shows *VW.DELAY XX*. "XX" is the number of seconds the drum waits before rotating after a vend.
2. Enter a new number between 10 and 99, if desired.
3. CONTINUE.



**SET DOOR DELAY TIME**

After a vend, the door will remain unlocked for a preset amount of time before locking:

1. Press , then  until the display shows *DR.DELAY XX*. "XX" is the number of seconds the drum remains unlocked after a vend.
2. Enter a new number between 10 and 99, if desired.
3. CONTINUE.

**SET AUTOMATIC DOOR DELAY TIME**



(This screen is only used if you machine is equipped with automatic vend doors).

1. Press , then  until the display shows *DR.OPEN XX*. "XX" is the number of seconds that the vend door will remain open.
2. Enter a new number between 1 and 99, if desired. Default time is 5 seconds.
3. CONTINUE



SET ALIGN/NO ALIGN OPTIONS

A customer may try to open a vend door when the compartment is one step out of alignment. This function allows you to choose whether the drum automatically corrects itself, or the customer gets a display instructing him to rotate the drum:

1. Press , then  until the display shows one of the following:

ALIGN ON - The drum moves itself to the correct position.



ALIGN OFF - If the customer attempts to open a vend door when the compartment is not aligned, the following message is displayed:

OFF-LINE, PUSH ARROWS

2. Press  until the option you want is displayed.
3. CONTINUE.



**TURN TAMPER CHECK ON OR OFF**

If a vend door has been moved and there is still a product in that location, it is considered to have been tampered with, and should not be sold. Proper operation of this feature assumes that you have configured the machine so that the actual number of compartments per tray agrees with the quantity you entered in "Set Number of Compartments" on page 37.

1. Press . Press  until the display shows one of the following:
TAMPER OFF - The tamper check feature is inoperative.
TAMPER ON - The tamper check feature is operating.
2. Press  to switch between tamper check on and off.
3. CONTINUE.

**CHECK FOR TAMPERING**







The following example shows you how to perform a tamper check on a machine that is configured to have 3 compartments per tray on all 9 levels. Our example machine has a total of 24 out of 27 possible items visible in the zone behind the delivery doors.

1. Press . Press  until the display shows - 10TY 23.
 This means that the tamper check feature is on and the machine thinks there are 23 items remaining behind the doors (the - 1 indicates that zone 1 is behind the doors). Remember that with 3 compartments per level, there is a maximum of 27 items that can be present behind the doors. Therefore, there is one item that is considered sold but is still present.
2. Next, look at the price displays. Each price display shows whether one or more of the products at that level has been sold. On level 1, the price display shows 3. | | |. The 3 is how many products are in the tray on level 1. The |s represent the compartments for that tray--a full 1 means the compartment should contain a product, a half | means the compartment should be empty. For example, the 3. | | | display indicates that all three compartments on level 1 should be full. You count the products on level 1, and they are all there. On level 2, the price display shows 2. | | |. This means that the middle compartment should be empty. If the middle compartment has a product in it, it may have been tampered with and should be removed.
3. After the product is removed, the number of full compartments agrees with the number 23 in the display. At this point, you can leave the function,

OR
4. Check for tampering in all of the other zones.
5. Fill all empty compartments, then press and hold . The display shows *CLEARING*, then *FINISHED*. You have now indicated that the drum is filled.
6. CONTINUE.

**TURN POWERSAVE ON OR OFF**

Use the Powersave feature to set up time intervals when the machine can turn off the lights and price displays to go into a low power mode.

1. Press , then  until the display shows *PLWRSAV* --- --. You can program up to three powersave intervals. Press 1, 2, or 3 to program a specific interval.
2. Press . The display will change to *1 PLWRSAV OFF* or *1 PLWRSAV ON*. Press  to toggle between the choices.
3. Press . The display will show *1 STRT 0.00*. Enter a powersave start time (in 24 hour format) using the keypad.
4. Press . The display will show *1 STOP 0.00*. Enter a powersave stop time (in 24 hour format) using the keypad.



NOTE:

The machine will also exit powersave if money is inserted, or an arrow key is pressed.



5. Press . The display will show *1 @ S M T W T F S*. Select what days the interval will operate by pressing numbers on the keypad (1= sunday, 2= monday, 3= tuesday, etc.).
6. CONTINUE.

**TURN GLASS HEATERS ON OR OFF**





The Shopper has small heaters in the vend doors to prevent condensation from building up and obscuring the view of the products. The heaters only operate when the cabinet temperature is below 45°. In some locations, these heater may be turned off to save power.

1. Press , then  until the display shows *HEAT ON* or *HEAT OFF*.
2. Press  to toggle the vend door heaters on or off.
3. CONTINUE.



**DISPLAY PRICES****(Supervisor Mode Only)**

1. Press , then  until the display shows *PRICE ON*.
2. Press  to turn it off. No prices will show in the price displays.
3. CONTINUE.

**CHANGE TEMPERATURE****(Supervisor Mode Only)**

1. Press , then  until something like *+/- +37°F* displays.
2. Press  to increase temperature,  to decrease temperature.
3. Press  to switch between Fahrenheit and Celsius.
4. CONTINUE.

**SHOW THE TEMPERATURE IN STANDBY MODE****(Supervisor Mode Only)**

1. Follow the steps in "Gain Access to the Supervisor Mode" on page 27.
2. Press , then  until something like *+/- +37°F* displays.
3. Press  a comma is added before the temperature *+/- +,37°F*. Close the door. The temperature will display in the ready message once the temperature setpoint is met.
4. CONTINUE.





SET DEFROST OPTIONS

(Supervisor Mode Only)



The Shopper has a built-in defrost cycle to ensure that ice does not build up on the evaporator coil. It may be necessary to adjust the defrost timing for locations with extremely warm and humid conditions (see unscheduled defrosts below).

1. Follow the steps in "Gain Access to the Supervisor Mode" on page 27.

2. Press , then  until the display shows *SETDEFROST*.

3. Press . The display will show *X/DAY*. "X" is the number of times per day that the defrost cycle operates. This can be set for 2, 3, or 4 times per day, with a default of 2.

Press  to change the value of X.

4. Press  until the display shows *FOR XXMIN*. XX represents how many minutes the defrost cycle operates. The default value is 20 minutes, but this value can be configured between 15-25 minutes. Press  to change the value of XX.

5. Press  until something like the following displays:

2 > NORM SINCE 2003 07/08 04.28



2 > NORM is a running total of the number of **Unscheduled Defrosts** the compressor has performed since July 8 at 4:28. The time is in 24 hour format.

The controller monitors the compressor operation and may determine that a defrost cycle is necessary in addition to the regularly scheduled defrost. If more than 3 unscheduled defrosts occur per month, check that the door seals properly. If no air leak is apparent, the scheduled defrost cycle can be increased in rate or duration as in steps 2 and 3 above.

6. If desired, press  to reset the counter to 0 and the counter date and time to the present.

7. CONTINUE.

**VIEW SOFTWARE VERSION**

1. Press . Press  until the display shows *VER XXXXXX*. "XXXXXX" represents the current software version number.
2. CONTINUE.

**SET THE TIME**



1. Press . The display shows *TIME HH.MM*. "HH.MM" is the time of day in 24-hour format.
2. Enter the current time using the number keys.

NOTE

9:00 am is entered with a leading zero, like this: 0900; 9:00 pm is entered as 2100.

3. CONTINUE.

**SET DAY OF THE WEEK, MONTH, DATE, AND YEAR**

1. Press , and press  until the display shows *XX/XX/XX Y*.
XX/XX/XX is the current date. Y is the day of the week, with sunday=1, monday=2, etc.
2. Press  to select date format DD-MM-YY or MM/DD/YY.
The default setting is DD-MM-YY.
3. Enter the correct date using the number keys.



NOTE

The Y will disappear and automatically adjust to the correct setting as soon as a valid date is entered. If an incorrect date is entered, press  to zero the date and then re-enter.

4. CONTINUE.

**SET DAYLIGHT SAVING TIME OPTION**

This option will automatically adjust the machine's clock for daylight savings.



1. Press , and press  until the display shows something like: *DST N.AMER*
2. Press  to select the appropriate option for your machine. The options are:

DST N.AMER (North America), *DST UK/EUR.*, *DST AUSUA*, *DST OFF*.

3. CONTINUE.

**SET TIME-OF-DAY INHIBITED VENDING**

Vending can be inhibited up to four times a day. This is useful when you want to reserve a zone for a later shift of workers.

1. Press , and press  until the display shows *INHIB* - - - - .
2. See “Time Interval Editing” on page 47 for an example of how to set up time-of-day inhibited vending.



NOTE

Zones inhibited under “Set Shop Zones” on page 37 are always inhibited.

3. CONTINUE.
-



**SET TIME-OF-DAY FREE VENDING**

Vending can be free up to four times a day.

1. Press , and press  until the display shows *FREEV* - - - - .
 2. Go to “Time Interval Editing” on page 47 for an example of how to set up a time interval.
 3. CONTINUE.
-

**SET TIME-OF-DAY DISCOUNT VENDING**

Vending can be discounted up to four times a day. For example, this can be used to favor early-arriving employees.

1. Press , and press  until the display shows *DISCT* - - - - .
2. Go to “Time Interval Editing” on page 47 for an example of how to set up a time interval.
3. CONTINUE.



TIME INTERVAL EDITING

You can select up to four times of day for each special vending period.



NOTE

If two or more of these time periods overlap, the interval with the highest priority will overrule the other(s). This order of precedence is:

1. INHIBIT
2. FREEVEND
3. DISCOUNT



For example, if a DISCOUNT time period is scheduled for a certain area before the end of an INHIBIT time period, DISCOUNT does not begin until the INHIBIT interval has ended for that area.







The time interval editing procedure is almost the same for the INHIBIT, FREEVEND, and DISCOUNT intervals. There is one difference for the DISCOUNT time interval, so we will use it in our example. Assume you just finished "Set Time-Of-Day Discount Vending" on page 46. Step 1 picks up where you left off...

1. The display shows *DISCT - - - -*. Press the number of the time interval (1-4) you want to edit, or  to edit time interval 1 (we'll use interval 1 for this example).
2. The display shows *IDISCT ON* or *IDISCT OFF*. This display tells you whether your time interval (represented by 1) is on or off. Press  to change the condition of the time interval.

NOTE



If you turn an interval ON, it must be edited. You can edit a time interval now, then turn it OFF until another time.

3. Press . The display shows *IDISCT X*. "X" represents the discount percentage for this period. Enter a discount percentage of 25 with the number keys. (Discount percentages of from 0 to 99 are permitted.) The machine will apply a 25% discount to each price, rounding up to the nearest nickel (or the smallest coin accepted by the coin mechanism).
4. Press . The display shows *ISTRT X.XX*. "X.XX" is the currently set start time. Enter a new start time (24-hour format) for this interval. To enter the time for 3:30 pm, enter 1530.
5. Press . The display shows *ISTOP X.XX*. "X.XX" is the currently set stop time. Enter a new stop time (24-hour format) for this interval. To enter the time for 6:00 pm, enter 1800. You have now established a 25% discount that starts at 3:30 pm and ends at 6:00 pm.

6. Press . The display shows *!@ - - - - -*. The dashes represent the days that this time interval is active. Pressing number keys 1 through 7 switches the days on/off (1=sunday, 2=monday, etc.). For example, press "2", "4", and "6". The display now shows *!@ - M - W - F -*.
This discount interval is only active on Monday, Wednesday, and Friday.
7. You can limit the Discount interval by Zone(s), Level(s), Tray(s), Individual Selection(s), or All Selections.
 - a. To limit the Discount interval to a specific **Zone**, press  until the display shows *ZONE*. Rotate the drum until the desired zone is in the vend position and slide any vend door in the valid vend position. A beep will sound, indicating that the zone is activated. Slide the door again to de-activate the zone. Add additional zones by rotating the drum until they are in the vend position and sliding a vend door in that zone.
 - b. To limit the Discount interval to a specific **Level**, press  until the display shows *LEVEL*. Rotate the drum until the desired level is in the vend position, then slide the vend door on that level. A beep will sound, indicating that the level is active. Slide the door again to de-activate it. Add additional levels by sliding the vend door on each level you wish to activate (make sure they are in the vend position).
 - c. To limit the Discount interval to a specific **Tray**, press  until the display shows *TRAY*. Rotate the drum until they tray you prefer is in the vend position, then slide the vend door of that tray. A beep will sound, indicating that the tray is active. Slide the vend door again to de-activate the tray. Slide vend doors for additional trays to activate multiple trays for the Discount Interval. The Trays you wish to activate **must** be in the vend position when you slide the vend door.
 - d. To limit the Discount interval to a specific **Selection**, press  until the display shows *EACH*. Rotate the drum until the compartment of the selection you prefer is in the vend position. Slide the vend door of the selection. A beep will sound, indicating that the selection is active. Slide vend doors to additional compartments to activate multiple selections for the interval. The compartment(s) you wish to activate **must** be in the vend position when you slide the vend door.
 - e. To configure the Discount interval for **All Selections**, press  until the display shows *ALL*, then slide any vend door that is in the valid vend position. A beep will sound, indicating the discount will apply to the entire machine. Slide the vend door again to de-activate the interval.







8. The price displays will show something like: 2 | | 1. The numeral is the number of compartments that the tray behind the vend door is configured for. The lines indicate which compartments are configured for the interval. A long line indicates that the compartment is activated for the interval. A short line indicates that the compartment is not included in the interval.

For example, in "2 | | 1", there are two compartments in the tray, with the first compartment active in the interval, while the second is locked out.



- i. For an **Inhibited Interval**, the first and third compartments are locked out, with the second one available for purchase.
 - ii. For a **Free Interval**, the first and third compartments are free during the free interval, while the second must be purchased.
 - iii. For a **Discount Interval**, the first and third compartments will be available at the discount price, but the second would remain full price.
9. Press . The display shows *1MSG OFF* or *1MSG X*. "OFF" means there is no custom message selected, and "X" represents the custom message number set for this interval. Press the number key of the message (1 through 8) you want displayed. To edit this message, press  and follow the procedure given in "Edit Custom Messages" on page 50. Press **0** to turn the message OFF for this time interval.
10. CONTINUE.



EDIT CUSTOM MESSAGES

1. Press , and press  until the display shows *EDIT MSG X*.
2. Press the number of the message you want to edit., then press . The message text is displayed with the first character flashing.
3. To view the message, press . The message scrolls across the display. Messages can be up to 64 characters in length, including the end of message character. To stop the scrolling, press .
4. When the character you want to change is flashing, enter it directly if possible, or use  and  to step through the character set until the desired character is displayed. Use the arrow keys to highlight different characters. See the section on the next page for an explanation of special keys and the character set.

SHORTCUT

Instead of stepping through the whole character set to enter a letter that is not on your keypad, enter one close to the one you want, then step to it. Example: If you want to enter an **L**, first press , then press  six times. Your **L** should now be displayed.

5. Once you have entered the message, place the end of message character as the last character and press .

THE END OF MESSAGE CHARACTER

This is the most important character in your message, because it tells the machine when the message is ended. If you don't use this character, your message will be followed by a series of zeros. This character can be selected either from the character set or by pressing .





ENTER YOUR MESSAGE

Most of the keys on the control panel have a special purpose to help you create and edit your messages:



-  Inserts an **R** at the flashing character.



 Inserts an **S** at the flashing character.

 Inserts a **T** at the flashing character.

 Repeats the letter to the left of the flashing character.

 "Pages" through the message, ten characters (one screen) at a time.

  Steps forward and backward through the message, one character at a time.

  Steps forward and backward through the character list, one character at a time. See the character list on the next page.
-  Inserts a space at the flashing character.

 Deletes the current character and closes up the space.

 Deletes the current character and leaves the space.



 Enters the special "end of message" character, which denotes the end of the message.

THE CHARACTER SET



0	A	J	U	{	
1	B	L	V	}	
2	C	M	W	*	
3	D	N	X	#	
4	E	O	Y	+	
5	F	P	Z	-	}
6	G	Q	(SPACE)	/	?
7	H	R	-	.	@
8	I	S	\$	<	0
9	J	T	'	=	⊗

6. CONTINUE.



**SELECT A STANDBY MESSAGE**

1. Press , and press  until the display shows *STANDBY XX*. "XX" represents the current message number selected to display when the machine is in standby mode.
2. To select a message, press the corresponding number (1 through 8). To display the factory-set message, press 0.
3. The selected message (except the factory-set message) can be edited. To do this, press  and follow the procedure given in "Edit Custom Messages" on page 50.
4. CONTINUE.

**SELECT AN OUT-OF-SERVICE MESSAGE**

1. Press , and press  until the display shows *SERVICE XX*. "XX" represents the current message number selected to display when the machine is out-of-service. Two dashes mean that the factory-set message is selected.
2. To select a message, press the corresponding number (1 through 8). To display the factory-set message, press 0.
3. The selected message (except the factory-set message) can be edited. To do this, press  and follow the procedure given in "Edit Custom Messages" on page 50.
4. CONTINUE.

**SELECT A FREEVEND MESSAGE**

1. Press , and press  until the display shows *FREEVEND XX*. "XX" represents the current message number selected for the message that displays when the machine is in the freevend mode. Two dashes mean that the factory-set message is selected.
2. To select a message, just press the corresponding number (1 through 8). To display the factory-set message, press 0.
3. The selected message (except the factory-set message) can be edited. To do this, press  and follow the procedure given in "Edit Custom Messages" on page 50.
4. CONTINUE.

**VIEW MACHINE TEMPERATURE**





1. Press . The display shows *TEMP 38⁰ F*. This example shows that the machine temperature is 38⁰ degrees Fahrenheit.

NOTE

The temperature reading may display one of the following instead of "TEMP", depending on conditions in the machine:







- XX.H* - XX is the number of minutes left in the health control grace period (See "Health Shutoff Control" on page 2)
 - HC.ER* - a health control error has occurred.
 - DEF* - the machine is currently in a passive defrost cycle
 - **X.X* - the temperature has been over the health control limit for x.x minutes.
2. If "!" replaces "F" or "C" after the temperature, then the temperature is invalid. The last valid temperature is shown. Check diagnostics for the cause, usually a faulty sensor.
 3. A decimal point following "F" or "C" indicates the software has turned the compressor on. If the compressor is not on, check the related wiring.
 4. A comma after the "F" or "C" indicates the software is currently performing a defrost.
 5. To change the display units, press . The display now shows *TEMP 3⁰ C*.
 6. CONTINUE.

**PAYOUT COINS**

1. Press . If a dumb mech was selected, the display shows *NDD - 123*; if an MDB mech was selected the display shows *PAY 123*.
2. Press . A dumb mech pays out one *N*ickel; an MDB mech pays a coin from tube 1.
Press . A dumb mech pays out one *D*ime; an MDB mech pays a coin from tube 2.
Press . A dumb mech pays out one *Q*uarter; an MDB mech pays a coin from tube 3.
3. To continuously pay out coins, hold down the appropriate key.
4. CONTINUE.



**SET PRICES**



Prices in the Shopper can be set by Level, Tray, Selection, or All (entire machine).

1. To set the price by **Level**, press . The display will briefly show *LEVEL Z.X* (where X is the current zone). Enter a price using the maintenance keypad. The display will show: *LEVEL 100*. Rotate the drum so the level you wish to set prices for is in the vend position and slide its vend door. A beep will sound and the price display will show *100* and all the selections on that level will be priced for \$1.00.
2. To set the price by **Tray**, press  and then  until the display shows *TRAY Z.X* (where X is the current zone). Enter a price using the maintenance keypad. The display will show: *TRAY 100*. Rotate the drum so the tray you wish to set a price for is in the vend position and slide the vend door. A beep will sound and the price display will show *100*. All products in that tray will be priced for \$1.00. Slide the vend door of a different tray to set it to \$1.00 as well.
3. To set the price by **Selection**, press  and  until the display shows *EACH Z.X* (where X is the current zone). Enter a price using the maintenance keypad. The display will show: *EACH 100*. Rotate the drum so the compartment you wish to set a price for is in the vend position and slide the vend door. A beep will sound and the price display will show *100*. The product in that compartment will be priced at \$1.00. Slide the vend doors of additional compartments to set their price to \$1.00 (make sure they are in the vend position first).
4. To set **All** selections in the machine to the same price, press  and  until the display shows *ALL Z.X* (where X is the current zone). Enter a price using the maintenance keypad. The display will show: *ALL 100*. Slide any vend door that is in the vend position. A beep will sound and the price displays will show *100*. All selections in the machine will be priced at \$1.00.

IMPORTANT NOTE:

You can combine the pricing options above to efficiently set prices in the machine to your preference. In the example below, the route driver wants to set the prices for all products in the bottom six levels at 1.00. The products in the top three levels will be priced at \$2.00, except for tray one on level 2, and the first compartment in tray 1 on level 3, priced at \$2.50.

- a. First, press  and  until the display shows *ALL Z.X*. Enter 1.00 and slide a vend door. All products in the machine are now priced at \$1.00.
- b. Press  until the display shows *LEVEL Z.X*. Enter 2.00 and slide the vend doors of levels 1-3. These levels are now priced at \$2.00, the bottom six at \$1.00.



- c. Rotate the drum so that zone 1 is in the vend position. Press  until the display shows *TRAY ZX*. Enter 2.50 and slide the vend door on Level 2. The products in tray 1 are priced at \$2.50, while the rest of the level stays at \$2.00.
- d. Make sure the first compartment of zone 1 is in the vend position. Press  until the display shows *EACH ZX*. Enter 2.50 and slide the door on level 3. The first compartment in that tray is priced at \$2.50, but the others stay at \$2.00.

NOTE

When in price mode, the last entered price remains active and does not need to be reentered for each selection. This is useful when pricing multiple individual selections that will have the same price.









5. CONTINUE.

**VIEW NONRESETTABLE SALES AND VEND DATA**

1. Press . The display shows *NR\$ XX.XX*. "XX.XX" is a dollar and cents figure showing the total of all sales in the machine. This is a running total, and therefore is not resettable.
2. Press . The display shows *NR X*. "X" is the total number of vends made by the machine. This is a running total, and therefore is not resettable.
3. CONTINUE.







VIEW TOTAL PAID SALES





1. Press , then press  until the display shows ***\$ XX.XX. "XX.XX" is a dollar and cents figure showing the total of all PAID sales in the machine (as opposed to unpaid sales like winner and free vends). This is the total since the last time it was cleared. The price displays will show the total paid sales for each level.
2. To view Total Paid Sales by **Zone**, press 1, 2, 3, 4 or 5. The display shows Z** XX.XX, where "Z" is the zone number you pressed and "XX.XX" is the total for all levels of the zone. Press  or  to view total sales for the other zones.
-or-
3. To view Total Paid Sales by **Level**, slide the door of the level you are interested in. The display shows *L* XX.XX, where "L" is the level number and "XX.XX" is the total for the entire level. Press  or  to switch between totals for all nine levels.
-or-
4. To view Total Paid Sales by **Selection**, press 1, 2, 3, 4, or 5, then slide the vend door on the level you are interested in. The display shows ZL* XX.XX, XX.XX is the total of the tray behind the vend door. Press  or  to cycle through the totals for each compartment in the tray.
5. CONTINUE.

**VIEW DISCOUNT SALES BY TIME INTERVAL****NOTE**

This does not appear if the total of discount sales is zero.



1. Press , then press  until the display shows *****\$ XX.XX**.
2. Press . The display shows **IDSC .00**. This is the total sales for discount interval 1.
3. Press  to view intervals 2 through 4, if applicable.
4. CONTINUE.

**VIEW TOTAL PAID VENDS**

1. Press , then press  until the display shows ***** XX**. "XX" is the total number of paid vendes for the entire machine. The price displays will show the total paid vendes for each level. Press 1 on the keypad to view the total paid vendes for Zone 1. Press  or  to view total vendes for the other zones.
2. CONTINUE.





**VIEW CARD READER PAID SALES****NOTE**

This does not appear if the total of card reader sales is zero.



1. Press , then press  until the display shows *****\$ XX.XX**.
2. Press  until the display shows **DBT XX.XX**. "XX.XX" is the amount of money collected from card reader sales.
3. CONTINUE.

**VIEW TOTAL UNPAID SALES****NOTE**



This does not appear if the total of unpaid sales is zero.

1. Press , then press  until the display shows **_0\$ XX.XX**. "XX.XX" is the value of the total unpaid sales (free vends, winner vends, 100% discounts, zero price vends) for the entire machine.
2. To view Total Unpaid Sales by **Zone**, press 1, 2, 3, 4 or 5. The display shows **Z** XX.XX**, where "Z" is the zone number you pressed and "XX.XX" is the total for the zone. Press  or  to switch between all five zones. The price displays show the total unpaid sales for that level of the current zone.

-or-





3. To view Total Unpaid Sales by **Level**, slide the door of the level you are interested in. The display shows ***L* XX.XX**, where "L" is the zone number and "XX.XX" is the total for the entire level. Press  or  to switch between all nine levels.

-or-

4. To view Total Unpaid Sales by **Selection**, press 1, 2, 3, 4, or 5, then slide the vend door on the level you are interested in. The display shows **ZL* XX.XX**, the total of the tray behind the vend door. Press  or  to cycle through the totals for each compartment in the tray.
5. CONTINUE.





**VIEW TOTAL UNPAID VENDS****NOTE**

This does not appear if the total of unpaid sales is zero.

1. Press , then press  until the display shows **_0 XX**. "XX" is the number total of unpaid vends (free vends, winner vends, 100% discounts, zero price vends) for the entire machine. The price displays will show the total unpaid vends for each level. Press 1 on the keypad to view the total unpaid vends for Zone 1. Press  or  to view total vends for the other zones.
2. CONTINUE.





**VIEW FREE VENDS****NOTE**

This does not appear if the Freevend total is zero.

1. Press , then press  until the display shows *.0\$ XX.XX*.
2. Press , then press  until the display shows *FRV XX.XX*. "XX.XX" is the total value of the machine-wide freevends.
3. CONTINUE.





**VIEW WINNERS****NOTE**

This does not appear if the winner total is zero.



1. Press , then press  until the display shows *.0\$ XX.XX*.
2. Press , then press  until the display shows *WIN XX.XX*. "XX.XX" is the total machine-wide winners.
3. CONTINUE.

**VIEW FREEVEND SALES BY TIME INTERVAL****NOTE**

This does not appear if the total of free vend sales is zero.

1. Press , then press  until the display shows *.0\$ XX.XX*.
2. Press , then press  until the display shows *IFRV .00*. This is the total sales for freevend interval 1, shown even if zero.
3. Press  to view intervals 2 through 4.
4. CONTINUE.

**VIEW TOTAL IN THE BILL VALIDATOR**

1. Press , then press  until the display shows *DBV XX.XX*. "XX.XX" is the total held in the bill validator.
2. Make sure to clear this total whenever the bill validator is emptied. With the validator total displayed, press and hold  until the display shows *CLEARING*, then *FINISHED*.
3. CONTINUE.



VIEW TIME DATA

1. Press , then press  until the display shows *TIME DATA*.

2. Press . A message similar to the following displays: *MAIN.1 237M 03/30 10.13*

This example shows the latest time interval the main (monetary) door was open (1). It was open for 237 minutes, and was opened on March 30 (03/30) at 10:13 am (10.13).

3. Press . If applicable, similar displays will appear for intervals 2, 3, and 4. Otherwise, go to the next step.

4. The following message displays: *AUX.1 33M 03/30 10.58*

This example shows the latest time interval the auxiliary (cold) door was open (1). It was open for 33 minutes (33M), and was opened on March 30 (03/30) at 10:58 am (10.58).

5. Press . If applicable, similar displays will appear for intervals 6, 7, and 8. Otherwise, go to the next step.

6. The following message displays: *HC.ERR 03/30 14.09 MAX. 69°F*

This example shows that the health control timer turned off on March 30 (03/30) at 2:09 pm (14.09), and the maximum temperature reached was 69°F.

NOTE

The temperature display units will be in °C if you selected Celsius during the temperature display function.

7. Press . The following message displays: *LAST POWER 03/30 13.51 FOR 00. 0.23*

This example shows that the last time the machine lost power was on March 30 (03/30) at 1:51pm (13.51) for zero days, zero hours, and 23 minutes (00. 0.23).

8. Press . The following message displays: *LONGST POWER 03/30 10.58 FOR 00. 2.47*

This example shows that the longest time the machine was without power was on March 30 (03/30) at 10:58am (10.58) for zero days, 2 hours and 47 minutes (00. 2.47).

9. Press . The following message displays: *FULL CLEAR 03/30 8.58*

This example shows that the last time resettable sales was fully cleared was on March 30 (03/30) at 8:58am (8.58).

10. Press . The following message displays: *TIME SET 03/30 9.15*

This example shows that the last time the time or date was set was on March 30 (03/30) at 9:15 am (9.15).

11. Press . The following message displays: *PRICE SET 03/30 9.42*

This example shows that the last time prices were set was on March 30 (03/30) at 9:42 am (9.42).



12. Press . The following message displays: *LASTVND XX*

XX is the last vend the machine performed.

13. CONTINUE.





VIEW MACHINE ID NUMBER



1. Press , then press  until the display shows *I.D. XXXXXXXX*. The X's represent the 8-digit machine ID number.
2. You can edit the machine ID number if the supervisor access code has been previously entered.
3. CONTINUE.



CLEAR ALL RESETTABLE DATA

1. Press . The display shows *NR\$ XX.XX*. This is a running total, and is not resettable.
2. Press and hold . Two beeps sound and the display shows *CLEARING* momentarily, and then changes to *FINISHED*. All data resettable is cleared.
3. CONTINUE.

**CLEAR PAID SALES DATA ONLY**

1. Press , then press  until the display shows *****\$ XX.XX**. "XX.XX" is a dollar and cents figure showing the total of all **PAID** sales in the machine (as opposed to unpaid sales like winner and free vends). This is the total since the last time it was cleared.
2. Press and hold . Two beeps sound and the display shows *CLEARING* momentarily, and then changes to *FINISHED*. All paid sales data is cleared; other data is saved.
3. CONTINUE.

**TEST VEND SELECTIONS AND VERIFY CREDIT ADDED**



1. Press . The display shows *TEST .00*. You may now test vend selections. If you insert money into the machine, the zeros in the display will be replaced with the amount of the credit. After the item vends, your money will be returned.

NOTE

You may make one more test vend if you close the door while still in TEST VEND mode.



2. CONTINUE.

**DOOR SOLENOID TEST**

1. Press , then press  until the display shows *SOL TEST*.
2. Press keypad numbers 1 through 9 or move the vend door to energize the different door solenoids.
3. Press 0 to turn all solenoids off. Otherwise the last solenoid will stay energized until you exit the test menu.
4. CONTINUE.

**TEST DOOR MOTOR**

(This screen is only on machine with automatic doors)

1. Press , then press  until the display shows *DOOR MTR*.
2. Press 1 through 9 or actuate a door to start the door motor.
3. After a pre-determined time the vend door should close.

4. To close the door early press the key for that level or press 0.
5. CONTINUE.



TEST DOOR HEATERS

1. Press , then press  until the display shows *HEAT XX*.

Note :

XX is the current state of the door heaters either ON or OFF.

2. Press  to toggle the heater ON or OFF.
3. CONTINUE.



TEST LAMPS

1. Press , then press  until the display shows *LAMP XX*.





Note:

XX is the current state of the door heaters either ON or OFF.

2. Press  to toggle the lamps ON or OFF.



TEST THE DISPLAY

1. Press , then press  until the display shows *DSPLY TEST*.
2. Press  to light all display segments; press  to turn them off.
3. Pressing a number key on the control panel causes all segments to display that character.
4. CONTINUE.

**DOWNLOAD DATA TO A PDCD**

1. Connect your portable data collection device (PDCD) per its operating instructions.
2. Press . Data is downloaded into your PDCD.

NOTE

Depending upon the setting selected in the “clearing data upon download” option, data may be cleared after the download is complete.





3. CONTINUE.







VIEW DIAGNOSTIC MESSAGES

1. Press . the display shows any of the following diagnostic messages, depending upon any fault(s) present:

<i>NO ERRORS</i>	None of the following errors are detected:
<i>CANT HOME</i>	No drum home position detected. If no other drum related errors are present, check if home switch operates properly. Machine will not operate.
<i>CARD.COMM</i>	Incomplete card reader communications. Check cables or replace unit.
<i>CARD.FCOMM</i>	Incomplete card reader communications - check cables. The card reader is not operational.
<i>CARD.ERR</i>	Card reader is indicating it has a problem.
<i>CARD.ERRXX</i>	Card reader has an error and indicates code XX. The code is defined by the card reader manufacturer. To correct, contact card reader manufacturer. The unit is still operational.
<i>CARD.FERR</i>	Card reader is indicating it has failed. Replace unit.
<i>CARD.FERRXX</i>	Card reader has failed and indicates code XX. The code is defined by the card reader manufacturer. To correct, contact card reader manufacturer.
<i>CARD.FJAM</i>	Card reader has failed because card is jammed in the unit. Remove the jammed card.
<i>CARD.SERV</i>	Card reader requires service. The unit is still operational.
<i>CHK CONFIG</i>	A PRODUCT CONFIG value was out of bounds and set to nominal - check all PRODUCT CONFIGs.
<i>CHK PRICE</i>	Price error detected and changed to maximum - check prices.
<i>DBV.ACCEPT</i>	The vending machine is telling the bill validator not to accept any bills. Check the enabled channels of the bill validator.
<i>DBV.COMM</i>	Incomplete bill validator communications -- check harness.
<i>DBV.JAM</i>	A bill is jammed in the acceptance path. The unit will disable itself until the error is corrected. Remove bill stuck in the acceptance path. Cycle machine power OFF and then ON.
<i>DBV.MOTOR</i>	One of the motors has failed. The unit will disable itself until the error is corrected. Check for bill stuck in the acceptance path. If no bill is present, replace the validator. Cycle machine power OFF and then ON.
<i>DBV.ROM</i>	ROM checksum failure. The unit will disable itself until the error is corrected. Replace the validator.
<i>DBV.SENSOR</i>	One of the sensors in the bill validator has failed. The unit will disable itself until the error is corrected. Check for bill stuck in the acceptance path. If no bill is present, replace the validator. Cycle machine power OFF and then ON.
<i>DBV.STACKR</i>	The stacker is open or removed. The unit will disable itself until the error is corrected. Install the stacker correctly. The stacker is full of bills. Remove bills from the stacker.
<i>DOOR LOCK X</i>	Lock circuit X (1-9) is currently unlocked.

<p><i>DOOR.X NN LOCK FAIL</i></p>	<p>The door mechanism lock switch “X” failed to return to the lock position “nn” times. Check the door lock mechanism for binding, interference, etc. Multiple tries to relock the door are only counted once. To clear error, press and hold  until the display shows <i>FINISHED</i>.</p>
<p><i>DOOR MOTOR --3---8-</i></p>	<p>Dashes are replaced by failed motor(s) level numbers. In this example motors 3 and 8 are not operational. To reset the motor(s) or clear and door motor error, open the doors in the door motor test screen.</p>
<p><i>DOOR.X NN UNLOCK FAIL</i></p>	<p>The door mechanism lock switch “X” failed to unlock “nn” times. Check the door lock mechanism for binding, interference, etc. Multiple tries to relock the door are only counted once. To clear error, press and hold  until the display shows <i>FINISHED</i>.</p>
<p><i>HC ERR.</i></p>	<p>Presently out of service because of a health control temperature error (MAX. xx°F). Machine will not operate.</p>
<p><i>KEYPAD XY</i></p>	<p>Key(s) x, y stuck.</p>
<p><i>LOST NNN</i></p>	<p>NNN is the number of times (up to 255) that the drum lost its position and had to re-home. If the number of times lost is excessive, check the drum solenoid or the drum solenoid lock pin switch adjustment. Also check that the slotted wheel and its sensor are free of dust and debris.</p> <p>Press  to view <i>XXX YYY/WK</i> (XXX is the number of re-homes today, YYY is the number for the last week). Press and hold  until the display shows <i>FINISHED</i>.</p>
<p><i>MECH.ACCEPT</i></p>	<p>Coin mechanism acceptor section is unplugged from the main body of the coin mech. Connect the cable and cycle machine power OFF and then ON.</p> <p>The vending machine is telling the coin mech not to accept any coins.</p>
<p><i>MECH.COMM</i></p>	<p>Incomplete coin mech communications -- check harness.</p>
<p><i>MECH.JAM</i></p>	<p>One or more coin tubes are jammed. Pay a coin from each tube until the jam is cleared.</p> <p>Coin is jammed in the acceptor section. Check the coin mechanism for a jam in this position. Insert coins and cycle machine power OFF and then ON.</p>
<p><i>MECH.ROM</i></p>	<p>Replace the coin mechanism.</p>
<p><i>MECH.SENSOR</i></p>	<p>Coin mech reporting a bad tube sensor - replace mech.</p>
<p><i>MOTOR JAM</i></p>	<p>Motor movement not detected in either direction. The merchandiser will try five times in succession to clear a jam by alternating directions. If the motor is still jammed, it will time out for five minutes, after which it will try to clear the jam again by alternating directions five times. Successive attempts to clear the jam at five minute intervals will continue for one hour (12 retries), after which the merchandiser will go out of service until serviced. If, during any of the retries, the motor jam is cleared, the merchandiser will go back into service.</p>

<i>NO DETECT X</i>	<p>X is the number of the door mechanism that was not detected the last time it was activated. The door mechanism may be open circuited or short circuited. Check the wiring from the Interface PCB to the lock mechanism solenoid.</p> <p>Clear the diagnostic error by actuating the solenoid through a TEST menu, or press and hold  until the display shows <i>FINISHED</i>.</p>
<i>NO MECH</i>	<p>Coin mech not detected - machine will not operate if configured for coin mech.</p>
<i>NONE READY</i>	<p>No selection is ready to vend. Check that no time-of-day inhibits are active.</p>
<i>NO WHEEL</i>	<p>No valid drum sensor wheel detected after command to turn drum. Machine will not operate.</p>
<i>RAM ERROR</i>	<p>One or more of the configuration settings may be incorrect. Check the machine settings (time of day, product dividers, pricing, etc).</p> <p>1. If the problem is corrected, the <i>RAM ERROR</i> message can be cleared by pressing  once.</p> <p>NOTE: If the source of the error is not resolved, pressing  will clear the error code, but will not resolve the problem.</p> <p>2. If you cannot find the problem, you can initialize your RAM by performing the following procedure:</p> <p>Press AND HOLD  until two beeps are heard and the display shows <i>FINISHED</i>. Reconfigure the merchandiser.</p> <p>IMPORTANT NOTE: Initializing RAM will erase all data and settings (price, time, monetary options, messages, etc). Be sure you have recorded this information and are ready to reprogram the machine from factory default settings before continuing.</p>
<i>ROM ERROR</i>	<p>Error in the programming EPROM. MACHINE WILL NOT OPERATE.</p>
<i>TAMPER 12345</i>	<p>Attempt to buy a sold compartment in zone 1, 2, or 3.</p>
<i>TEMP RANGE</i>	<p>The temperature sensor is out of range.</p>
<i>TEMP REF</i>	<p>The temperature reference on the main PCB cannot be read.</p>
<i>TEMP SNS</i>	<p>The temperature sensor cannot be read.</p>
<i>SHORT CKT -</i>	<p>Control board sensing one or more door solenoid(s) are shorted.</p>

2. CONTINUE.

**SET FREEVEND OPTIONS**

1. Press  until one of the following is displayed:

FREE OFF - Normal vending mode. No items are on freevend. A closure on the keyswitch input causes the machine to go out of service.

FREE ALL - All items are on freevend. The credit display shows *NO MONEY REQUIRED*

A closure on the keyswitch causes the machine to go out of service.

FREE W/KEY - All items are freevended while there is a closure on the keyswitch input. Normal cash sales are supported when the keyswitch input is open.

FREE ONCE - A closure on the keyswitch input causes only the next item to be freevended. Coin mechanism errors are ignored. This state is designed for card or token systems where one item is vended per token. Normal cash sales are also supported.

2. Press  until the option you want is displayed.
3. CONTINUE.

Section 6: Service and Sanitation

Sanitation is an important aspect of merchandiser operation. The lack of proper service and sanitation can cause merchandiser malfunction and loss of sales.

The periods and suggested procedures for service and sanitation are daily, weekly, monthly, and semi-annually. These periods and procedures are given as guides only, and are not to be construed as absolute or invariable. Local conditions must always be taken into consideration. Certain installations require that some or all of the steps under Monthly Service and Sanitation be performed weekly. Each merchandiser must be maintained individually in accordance with its particular requirements. National Vendors, however, stresses "A CLEAN MERCHANDISER IS THE MOST PROFITABLE MERCHANDISER".

Sanitizing means effective bactericidal treatment of clean surfaces of equipment and utensils by a process which has been approved by the health authority as effective in destroying microorganisms, including pathogens.

Sanitizing processes generally accepted by the health authority are as follows:

1. Immersion for at least one-half minute in clean hot water at a temperature not lower than 170° F (77° C).
2. Immersion for a period of at least one minute in a sanitizing solution containing:
 - a. At least 50 ppm of available chlorine at a temperature not lower than 75° F (24° C);
OR
 - b. At least 12.5 ppm of available iodine in a solution having a pH not higher than 5.0 and a temperature not lower than 75° F (24° C);
OR
 - c. Any other chemical-sanitizing agent that has been proven to be effective and non-toxic under usage conditions, and for which a suitable field test is available.
3. The following warnings and cautions are applicable to the service and sanitation procedures given in this section:

CAUTION

Milk and other foods are perishable products. Follow local health authorities' rules and regulations for storage and handling of these items.

IMPORTANT

All loose food particles or spillage, whether wet or dry, must be removed from the inside and outside of the merchandiser.

CAUTION

Do not get electrical connections or electrical components damp or wet.

NOTICE

Do not use waxes or lubricants that contain silicone on or in the merchandiser. Silicone or silicone vapors can cause electrical failure.

GENERAL

Set the main power switch OFF before cleaning or servicing the merchandiser. Use aerosol spray cleaners or spray waxes only in well-ventilated areas. NEVER use any spray product containing silicone. Silicone sprays can coat electrical contacts, causing a machine malfunction.

WARNING

Before using any liquid cleaner, unplug the merchandiser power cord or shut off power to the wall receptacle to avoid any possibility of electrical shock. Make certain all components are thoroughly dry and properly installed before restoring power.

Refer to the Parts Manual for additional service information and replacement parts. For factory assistance, contact the nearest National Vendors representative.

Contact the local health authorities and obtain their acceptance of the sanitizer you intend to use when cleaning and sanitizing the merchandiser.

When cleaning and sanitizing the merchandiser, use CLEAN, DISPOSABLE PAPER WIPES rather than cloths.

DAILY SERVICE

1. Replace burned-out or discolored light bulbs.
2. Replenish coin tubes in the coin mechanism.
3. Empty the bill validator as shown.
4. Test vend the merchandiser. See "Test Vend Selections and Verify Credit Added" on page 62.
5. Check the temperature of the cabinet. See "View Machine Temperature" on page 53.
6. Follow the daily sanitation procedures, then reload the merchandiser.

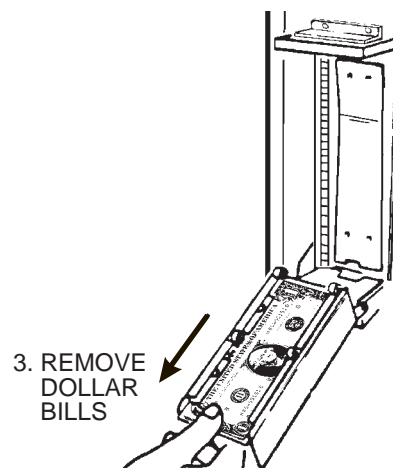
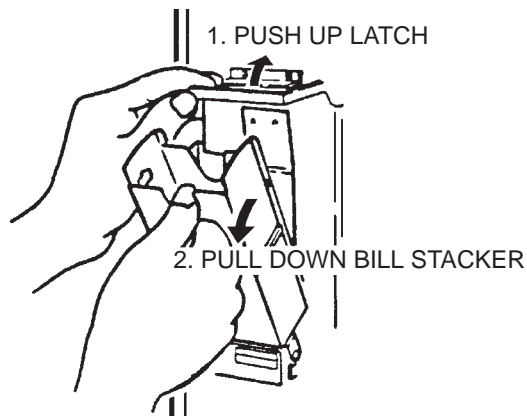

DAILY SANITATION

1. Remove all past-date merchandise from the merchandiser.
2. Check for liquid spillage on the merchandiser modules. If there is spillage, remove the module shelves and dividers affected. Wash and sanitize the shelves and dividers with a clean, damp disposable paper wiper or a clean, soft-bristle brush. Rinse with clean hot water and dry thoroughly.
3. Wipe the exterior of the merchandiser with a damp disposable paper wiper and dry thoroughly.
4. Fill in the appropriate columns on the record of cleaning card.

WEEKLY SERVICE

1. Follow the daily service instructions.
2. Inspect the inlet and outlet refrigeration screens. Remove any accumulated dust.
3. Inspect the coin mechanism, coin validator, and bill validator. Clean if necessary.
4. Verify vend doors move smoothly. Remove accumulated dust, dirt or food particles from tracks. Doors can be removed easily for more thorough cleaning of doors and tracks with a brush or soap and water.

WEEKLY SANITATION

1. Follow the daily sanitation instructions.
2. Inspect the merchandiser for overall cleanliness, especially the corners.
3. Wash and sanitize the merchandiser food compartment with a clean, damp disposable paper wiper. Dry thoroughly.
4. Fill in the appropriate columns on the record of cleaning card.

MONTHLY SERVICE

1. Follow the weekly service instructions.

WARNING

Be sure the area is well ventilated and no open flames are present before using any aerosol spray can.

WARNING

Use protective glasses or a protective shield if an air hose is used for drying.

2. Clean the coin chute and coin validator. (See "Cleaning the Coin Validator and Coin Chute" on page 72.)
3. Clean the bill validator. (See "Cleaning the Bill Validator" on page 72.)

MONTHLY SANITATION

1. Follow the weekly sanitation procedures.
2. Fill in the appropriate columns on the record of cleaning card.

SEMI-ANNUAL SERVICE

1. Follow the weekly service instructions.
2. Inspect the merchandiser for worn parts and replace where necessary.

NOTICE

Do not use silicone lubricants. Silicone can cause electrical contact failures.

National Vendors recommends using Lubriplate Portable Tool Grease No. 905 (or equivalent), available from:

Industrial Lubricating Company, Inc.
P.O. Box 3871
St. Louis, MO 63122

3. Lubricate the drive motor stop pin. **DO NOT OVER-LUBRICATE!**
4. Lubricate all moving parts that do not come into contact with food.

SEMI-ANNUAL SANITATION

1. Follow the monthly sanitation instructions.

CLEANING THE COIN VALIDATOR AND COIN CHUTE

Inspect the coin validator and coin chute at regular intervals. Clean them on approximately a monthly schedule.

1. Remove the coin validator assembly from the merchandiser.
2. Clean the coin chute with a tube cleaning brush to remove any accumulated dust and foreign matter.
3. Refer to the coin validator instruction booklet and follow the recommended cleaning procedure.

CLEANING THE BILL VALIDATOR

1. Refer to the bill validator instruction booklet and follow the recommended cleaning procedure.

CLEANING LEXAN OR GLASS

1. To clean the lexan or glass, use a mild dish soap only like Ivory. Using chemicals might damage the lexan or glass.

A	Drum Assembly Removal	18
Adjust the Stop Pin		17
Align/NoAlign Options		40
B	E	
Bill Count, Incorrect	Edit Custom Messages	50
Bill Selection Method	End of Message Character	50
Bill Validator, Set	Error Messages	65
Button	F	
Code	Forced Vend	34
Data Recall	Free Vends, View	59
Diagnostics	FreeVend Interval	47
F1	Freevend Message, Set	52
F2	Freevend Options, Set	68
Pay	Freevend Sales by Time Interval	59
Price	G	
Product Configuration	Glass Heaters	42
Test	I	
C	Inhibit Interval	47
CA304 setting	Install	
Card Reader Paid Sales, View	Coin Mechanism	6
Card Reader, Setup	Door Lock	8
Change Temperature	Money Box Lock	8
Check for Tampering	Installing Automatic Vend Doors	14
Coin Mechanism, Setup	L	
Compartments, Set Number	Load the Merchandiser	21
Custom Message, Edit	M	
D	Machine Configuration	25
Data Clearing Access	Machine ID Number	61
Data Recall Code	Machine Temperature, View	53
Date, Set	Mode Keys, Lock or Unlock	29
Daylight Savings Options, Set	Monetary Options, Setup	34
Defrost Options	N	
Delivery Door Stops, Adjust	Nonresettable Sales Data	55
DEX +CLR	Non-standard Bill Validator, Setup	33
DEX NR	O	
DEX ONLY	Operating Automatic Vend Doors	15
Dex Options, Set	Out-of-Service Message	52
Diagnostic Messages, View	P	
Discount Interval	Paid Sales Data Only, Clear	62
Discount Sales by Time Interval, View	Payout Coins	53
Display Language, Set	Payout Keys, Lock or Unock	29
Display Prices	PDCD, Download to	64
Display, Test	Prices	
Door Delay Time, Set	Set All	54
Door solenoid test	Set by Level	54
Download Data	Set by Selection	54

Set by Tray	54	Supervisor Mode, Gain Access	27
Prices, Set	54	T	
Printer Baud Rate, Select	30	Talker Mode	29
Printer Options, Set	29	Tamper Check	41
Product Dividers, Adjust	9	Temperature, Show in Standby Mode	43
Programming Flow Chart	25	Test	
R		Display	63
Resettable Data, Clear	61	Door Solenoid Test	62
Revalue Option	33	Test Door Heaters	63
S		Test door motor	62
Service and Sanitation	69	Test lamps	63
Set		Vend Selections	62
Daylight Savings Option	45	Time Data, View	60
Defrost Options	44	Time Interval	
Setup		Limit by Level	48
Align/No Align Options	40	Limit by Selection	48
Bill Validator	32	Limit by Tray	48
Card Reader	33	Limit by Zone	48
Coin Mechanism	31	Set All Selections	48
Compartments	37	Time Interval Editing	47
Date	45	Time, Setup	45
Display Language	31	Time-Of-Day Discount Vending	46
Door Delay Time	39	Time-Of-Day Free Vending	46
Freevend Message	52	Time-of-Day Inhibited Vending	46
Freevend Options	68	Total Paid Sales, View	56
Monetary Options	34	Total Paid Vends, View	57
Non-standard Bill Validator	33	Total Unpaid Sales, View	58
Out-of-Service Message	52	Total Unpaid Vends	58
PowerSave	42	U	
Prices	54	Unscheduled Defrost	44
Printer Baud Rate	30	V	
Printer or Dex Options	29	Vend Fail Credit	35
Set Automatic Door Delay Time	39	Verify Credit Added	62
Standby Message	52	View	
Time	45	Bill Validator Total	59
Time-Of-Day Discount Vending	46	Card Reader Paid Sales	57
Time-Of-Day Free Vending	46	Diagnostic Messages	65
Time-Of-Day Inhibited Vending	46	Discount Sales by Time Interval	57
Vend Fail Credit	35	Free Vends	59
View Delay Time	39	Freevend Sales by Time Interval	59
Winner Mode	36	Machine ID Number	61
Zone Preference	39	Machine Temperature	53
Shelf Assembly Removal	13	Nonresettable Sales Data	55
Shop Zones, Lock Out	37	Software Version	45
Software Version, View	45	Time Data	60
Standby Message	52	Total Paid Sales	56
Supervisor Code, Enter New	27		

Total Paid Sales by Level	56
Total Paid Sales by Zone	56
Total Paid Vends	57
Total Unpaid Sales	58
Total Unpaid Sales by Level	58
Total Unpaid Sales by Zone	58
Total Unpaid Vends	58
Winners	59
View Delay Time, Set	39

W

Winner Mode	36
-------------------	----

Winners

Limit by Level	36
Limit by Selection(s)	37
Limit by Tray	36
Limit by Zone	36
Set All	37

Winners, View	59
---------------------	----

Z

Zone Preference, Set	39
----------------------------	----

Terms and Conditions of Sale

LIMITED WARRANTY: Subject to the limitation specified herein, all parts included on original equipment manufactured by CRANE MERCHANDISING SYSTEMS and sold to purchaser are warranted for two (2) years from the date of shipment of the equipment in question. This warranty applies only to the original purchaser of the Merchandiser and is null and void if the Merchandiser is sold during the period of warranty.

Defective parts will be repaired or replaced free of charge when the defective part is returned, with transportation charges prepaid by purchaser, to a destination designated by CRANE MERCHANDISING SYSTEMS.

This warranty does not include any cost of service rendered or repairs made by customer or its agents on Merchandiser, or parts, unless authorization to incur such expense has been given in writing by CRANE MERCHANDISING SYSTEMS prior to incurring such expense. This warranty covers labor and service charges performed by CRANE MERCHANDISING SYSTEMS service technicians for the first 90 days of ownership from date of shipment.

This warranty does not apply to A) electrical components, wiring, or circuits or mechanical parts or assemblies damaged as a result of operating the Merchandiser at other than the design voltage and frequency specified on the Electrical Rating Tag, or B) in event of vandalism, fire or negligence, or C) incandescent lamps, neon lamps, fluorescent lamps, ballasts, starters or other expendable items, or D) when seal is broken on electronic boards, or E) when other manufactured components are installed in CRANE MERCHANDISING SYSTEMS Merchandisers.

Replacement parts sold by CRANE MERCHANDISING SYSTEMS as After Market shall be covered for three months from the date shown on the parts invoice. Purchaser must obtain prior RETURN AUTHORIZATION for return of all parts, following guidelines given by CRANE MERCHANDISING SYSTEMS. New, unused parts purchased as After Market can be returned within 30 days from date of parts invoice, with prior authorization from CRANE MERCHANDISING SYSTEMS.

THIS WARRANTY IS IN LIEU OF ALL OTHER WARRANTIES EXPRESS OR IMPLIED, INCLUDING WITHOUT LIMITATION, WARRANTIES OF MERCHANTABILITY OF FITNESS FOR A PARTICULAR PURPOSE. CRANE MERCHANDISING SYSTEMS SHALL NOT BE RESPONSIBLE FOR CONSEQUENTIAL OR PUNITIVE DAMAGES. CRANE MERCHANDISING SYSTEMS neither assumes nor authorizes any person to assume for it any obligation or liability in connection with the sale of said equipment or any part thereof.

